



**Kashmir™**  
MICROPHONE PREAMPS

# MixPre II Series

Multichannel Recorders | Mixers | USB Audio Interfaces

User Guide

**SOUND**  **DEVICES**

## Legal Notices

Product specifications and features are subject to change without prior notification.

Copyright© 2019 Sound Devices, LLC. All rights reserved. This product is subject to the terms and conditions of a software license agreement provided with the product, and may be used in accordance with the license agreement. This document is protected under copyright law. An authorized licensee of this product may reproduce this publication for the licensee's own personal use. This document may not be reproduced or distributed, in whole or in part, for commercial purposes, such as selling copies or providing educational services or support. This document is supplied as a technical guide. Special care has been taken in preparing the information for publication; however, since product specifications are subject to change, this document might contain omissions and technical or typographical inaccuracies. Sound Devices, LLC does not accept responsibility for any losses due to the user of this guide.

## Trademarks

The "wave" logo is a registered trademark and Kashmir is a trademark of Sound Devices, LLC. iPad, iPhone, Mac and OS X are trademarks of Apple Inc., registered in the U.S. and other countries. Windows is a registered trademark of Microsoft Corporation in the U.S. and other countries. Bluetooth Smart is a registered trademark of Bluetooth SIG, Inc. ASIO is a registered trademark of Steinberg Media Technologies. All other trademarks herein are the property of their respective owners.



## WEEE Statement

If you wish to discard a Sound Devices product in Europe, contact Sound Devices UK Service Center: +44 (0)1494 511711 for further information.



**Warning!** This device can drive headphones to potentially dangerous levels. Do not listen at high volume levels for long periods.

Read and fully understand this manual before operation.

## Manual Conventions

SYMBOL	DESCRIPTION
>	This symbol is used to show the order in which you select menu commands and sub-options, such as: Main Menu > Outputs indicates you press the Menu button for the Main Menu, then scroll to and select Outputs by pushing the Encoder.
[ ]	This symbol is used to convey selectable menu items.
*	This symbol is used to convey factory default settings.
+	A plus sign is used to show button or keystroke combinations. For instance, Ctrl+V means to hold the Control key down and press the V key simultaneously. This also applies to other controls, such as switches and encoders. For instance, MIC+HP turn means to slide and hold the MIC/TONE switch left while turning the Headphone (HP) encoder. METERS+SELECT means to hold the METERS button down as you press the SELECT encoder.
<b>Note</b>	A <i>note</i> provides recommendations and important related information. The text for notes appears italicized.
*	A cautionary warning about a specific action that could cause harm to you, the device, or cause you to lose data. Follow the guidelines in this document or on the unit itself when handling electrical equipment. The text for cautionary notes also appears italicized and bold in a different color.

## MixPre II User Guide | Rev 4-B | 07/20

This document is distributed by Sound Devices, LLC in online electronic (PDF) format only. Published in the USA.

**This table provides the revision history and cross-reference links to "what's new" in this guide.**

REV #	DATE	VERSION	DESCRIPTION
<b>1-A</b>	08/19	A	v4.00 Initial release
<b>2-A</b>	11/19	A	v5.00. MixAssist, USB hub support, USB routing matrix.
<b>3-A</b>	1/20	A	v6.00 32-bit float USB Audio Interface
<b>4-A</b>	6/20	A	v7.00 Support for NoiseAssist, output delay, support for P.I. Engineering X-Keys
<b>4-B</b>	7/20	B	v7.10 Support for front panel lock, additional USB Keyboard shortcuts

**SOUND**  **DEVICES**

Post Office Box 576  
E7556 State Rd. 23 and 33  
Reedsburg, Wisconsin 53959 USA  
[www.sounddevices.com](http://www.sounddevices.com)

+1 608.524.0625 main  
+1 608.524.0655 fax  
800.505.0625 toll free  
[support@sounddevices.com](mailto:support@sounddevices.com)

# Welcome to the MixPre II

**VERSATILE. DURABLE. HIGH-PERFORMANCE.**

If you record field audio, sound effects, audio for film, podcasts, voice-overs, music, or are just starting your audio journey, the MixPre II Series is for you! Lightweight, durable, and small, this powerhouse audio recorder and USB interface will help you capture audio for any application.

With Sound Devices' hand-crafted, crystal-clear, ultra low-noise Kashmir preamps, you'll record audio in superior quality - all the way up to a 32-bit float bit depth and a 192 kHz sample rate. This newest generation of Sound Devices' award-winning MixPre Series has been redesigned for increased performance and an astounding 142 dB of dynamic range.

The MixPre II is highly customizable to your needs. Record internally to a compatible SD card on set or stream your podcast over USB to your computer at home. Power with your computer, wall power, or record in the middle of nowhere with AA or Sony L-mount batteries. Adjust limiters, bit depth, sample rates, gain, pan, low-cut, phase inversion and phantom power to your liking. Use the MixPre's high-precision internal timecode generator to trigger the camera, or feed timecode in. The choice is yours!

Professionals love the flexibility of the MixPre Series. Don't need all those options? Basic mode has you covered.

All models are rugged, lightweight, and small, so you can throw it in a bag or mount it to a tripod or camera - or get situated on set with our Wingman App and one of our four supported USB control surfaces. With the superior sound and build quality that you can expect from the industry leader in production audio recording, your MixPre II can capture audio for any application. Our friendly and knowledgeable support team, based in the USA and Germany, is here for all your questions and comments. **Our job is to make your job easier.**

## **CUSTOMIZE WITH PLUGINS**

Are you a songwriter or musician? Buy the **Musician Plugin** to easily create a song using your MixPre II as a standalone recorder or USB interface. Use onboard features like overdub, bounce, reverb, and tracking to a metronome. Create Music Projects to lay down backing tracks and use them live or at home for writing or practicing. Capturing your song ideas has never been easier!

Download the **Ambisonics Plugin** to record in 360° audio and monitor binaurally with an ambisonic microphone like the Sennheiser AMBEO and a MixPre-6 II or MixPre-10 II.

Using multiple microphones with your MixPre II?  
Download the **MixAssist Plugin** to reduce unwanted room noise, feedback, or comb filter artifacts while recording.

Suppress background noise instantly on-location with the **NoiseAssist Plugin** for MixPre II Series. NoiseAssist is an advanced signal processing algorithm that reduces background noises such as traffic, generators, HVAC noise, and more. One instance of NoiseAssist can run on any channel, bus L, or bus R.

All plugins may be downloaded from the [Sound Devices Store](#).

**We are honored to be part of your kit.**

Sincerely,  
Sound Devices

## Table of Contents

<b>PANEL VIEWS</b>	<b>3</b>
<b>MIXPRE-3 II</b>	<b>3</b>
<b>MIXPRE-6 II</b>	<b>4</b>
<b>MIXPRE-10 II</b>	<b>5</b>
<b>POWERING THE MIXPRE II</b>	<b>6</b>
<b>POWER SWITCHOVER AND PRIORITY</b>	<b>6</b>
<b>TOUCHSCREEN</b>	<b>7</b>
<b>TRANSPORT CONTROLS</b>	<b>8</b>
<b>NAVIGATING MENUS</b>	<b>9</b>
<b>CHOOSING YOUR MODE</b>	<b>10</b>
<b>CUSTOM MODE</b>	<b>16</b>
<b>CHANNEL SCREEN - BASIC MODE</b>	<b>17</b>
<b>CHANNEL SCREEN - ADVANCED MODE</b>	<b>18</b>
<b>LINKING CHANNELS</b>	<b>19</b>
<b>INPUTS MENU</b>	<b>20</b>
<b>METERING</b>	<b>22</b>
<b>METERING BALLISTICS</b>	<b>22</b>
<b>LIMITERS</b>	<b>23</b>
<b>OUTPUTS</b>	<b>24</b>
<b>HEADPHONE OUT</b>	<b>26</b>
<b>FRONT PANEL LOCKS</b>	<b>27</b>
<b>USING THE MIXPRE II AS A</b>	<b>28</b>
<b>USB AUDIO INTERFACE</b>	<b>28</b>
<b>USB OUTPUT ROUTING</b>	<b>30</b>
<b>SYSTEM</b>	<b>31</b>
<b>TIMECODE</b>	<b>35</b>
<b>TIMECODE MODES</b>	<b>36</b>
<b>PRESETS</b>	<b>37</b>
<b>PROJECTS</b>	<b>37</b>
<b>FILE LIST - BASIC MODE</b>	<b>38</b>
<b>FILE LIST - ADVANCED MODE</b>	<b>39</b>
<b>CUE MARKS</b>	<b>40</b>
<b>USING STAR SHORTCUTS (*/**)</b>	<b>41</b>
<b>MIXPRE-6 II</b>	<b>41</b>
<b>MIXPRE-10 II</b>	<b>41</b>
<b>WINGMAN APPLICATION</b>	<b>42</b>
<b>USB KEYBOARD</b>	<b>45</b>
<b>MIXPRE-3 II SPECIFICATIONS</b>	<b>53</b>
<b>MIXPRE-6 II SPECIFICATIONS</b>	<b>54</b>
<b>MIXPRE-10 II SPECIFICATIONS</b>	<b>55</b>

# Panel Views

## MIXPRE-3 II

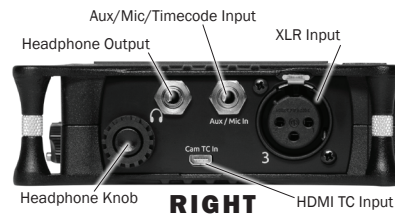
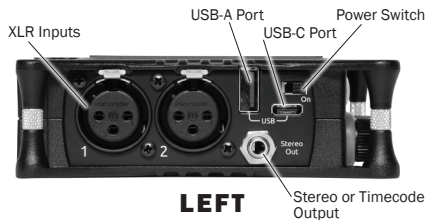
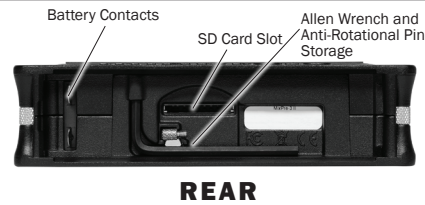
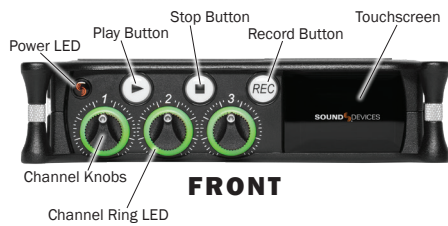

**POWER LED** Glows when the MixPre II is powered on.

**CHANNEL KNOBS** Sets the input gain for the channel. Press in on knob to access channel screen.

**CHANNEL LED RING** Provides visual indication of channel signal condition, solo and mute.

**PLAY BUTTON** Press to begin playback. While in playback the button glows green. See Transport.

**STOP BUTTON** Press to stop recording or playback. While stopped the button glows orange. See Transport.

**RECORD BUTTON** Press to begin a recording. While recording the button glows red. While copying in idle, the button flashes red. See Transport.

**TOUCH SCREEN** The sunlight-viewable, high-resolution, touch-screen is used to navigate the MixPre II user interface.

**BATTERY CONTACTS** Accepts power sled accessories designed for MixPre II. Allows powering from AA or Sony L-Mount batteries, such as the included MX-4AA.

**SD CARD SLOT** Insert SD card for recording.

**ALLEN WRENCH & ANTI-ROTATIONAL PIN** Magnetically attaches to the MixPre II for safe keeping. Used to attach MixPre II to cameras and tripods via ¼-inch-20-thread captive screw on MixPre II top panel.

**INPUTS 1-3 FEMALE XLR JACKS** Active-balanced analog microphone or line-level inputs. Inputs 1-2 on left panel, input 3 on the right. [pin-1 = ground, pin-2 = hot (+), and pin-3 = cold (-)]

### USB-A PORT

1. USB keyboard.
2. Auto-copy to USB drives.
3. USB to approved 3rd party control surfaces.
4. USB hubs to support multiple devices.

### USB-C PORT

1. Provides power to the unit.
2. Connects to computer as a USB Audio Interface.
3. Connects to computer for transferring files from the SD card.

**STEREO OR TIMECODE OUTPUT** Unbalanced stereo 3.5 mm female connector. Routing determined in the Outputs menu. [Sleeve = ground, tip = X1, ring = X2].

**POWER SWITCH** Turns the power on and off.

**HEADPHONE OUTPUT** 3.5 mm TRS headphone output. Warning! This output can drive headphones to potentially dangerous levels. [Sleeve = ground, tip = left, ring = right]

### HEADPHONE KNOB

1. Rotate to control headphone volume.
2. Rotate to navigate some menus and the virtual keyboard. Press in to select items.

**AUX/MIC/TIMECODE INPUT** Menu-selectable input. Accepts unbalanced stereo audio signal, Plug in Power microphones, or LTC timecode.

**HDMI TC INPUT** Connect to select cameras to receive HDMI timecode and record start/stop flags.

**MIXPRE-6 II**

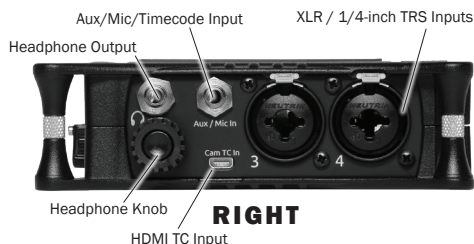
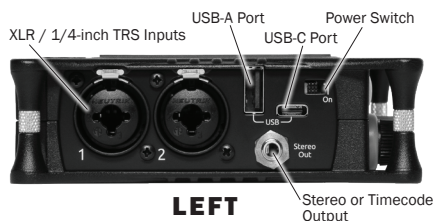
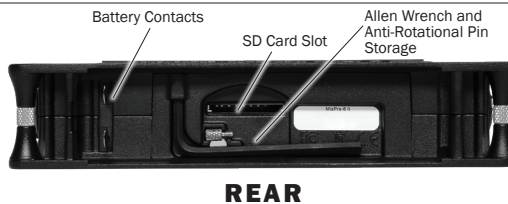
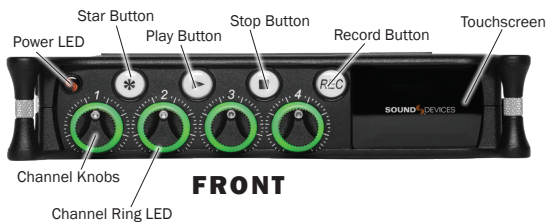

**POWER LED** Glows when the MixPre II is powered on.

**CHANNEL KNOBS** Sets the input gain for the channel. Press in on knob to access channel screen.

**CHANNEL LED RING** Provides visual indication of channel signal condition, solo and mute.

**STAR (\* & \*\*) BUTTON** Provides a user-assignable hardware button to frequently used functions. See Shortcuts.

**PLAY BUTTON** Press to begin playback. While in playback the button glows green. See Transport.

**STOP BUTTON** Press to stop recording or playback. While stopped the button glows orange. While copying in idle, the button flashes red. See Transport.

**RECORD BUTTON** Press to begin a recording. While recording the button glows red. While copying in idle, the button flashes red. See Transport.

**TOUCH SCREEN** The sunlight-viewable, high-resolution, touchscreen is used to navigate the MixPre II user interface.

**BATTERY CONTACTS** Accepts power sled accessories designed for MixPre II. Allows powering from AA or Sony L-Mount batteries, such as the included MX-4AA.

**SD CARD SLOT** Insert SD card for recording.

**ALLEN WRENCH & ANTI-ROTATIONAL PIN** Magnetically attaches to the MixPre II for safe keeping. Used to attach MixPre II to cameras and tripods via 1/4-inch-20-thread captive screw on MixPre II top panel.

**INPUTS 1-4 FEMALE XLR / 1/4" TRS COMBO JACKS** Active-balanced analog microphone or line-level inputs. Inputs 1-2 on left panel, inputs 3-4 on the right. [pin-1 = ground, pin-2 = hot (+), and pin-3 = cold (-)]

**USB-A PORT**

1. USB keyboard.
2. Auto-copy to USB drives.
3. USB to approved 3rd party control surfaces.
4. USB hubs to support multiple devices.

**USB-C PORT**

1. Provides power to the unit.
2. Connects to computer as a USB Audio Interface.
3. Connects to computer for transferring files from the SD card.

**STEREO OR TIMECODE OUTPUT** Unbalanced stereo 3.5 mm female connector. Routing determined in the Outputs menu. [Sleeve = ground, tip = X1, ring = X2].

**POWER SWITCH** Turns the power on and off.

**HEADPHONE OUTPUT** 3.5 mm TRS headphone output. Warning! This output can drive headphones to potentially dangerous levels. [Sleeve = ground, tip = left, ring = right]

**HEADPHONE KNOB**

1. Rotate to control headphone volume.
2. Rotate to navigate some menus and the virtual keyboard. Press in to select items.

**AUX/MIC/TIMECODE INPUT** Menu-selectable input. Accepts unbalanced stereo audio signal, Plug in Power microphones, or LTC timecode.

**HDMI TC INPUT** Connect to select cameras to receive HDMI timecode and record start/stop flags.

**MIXPRE-10 II**

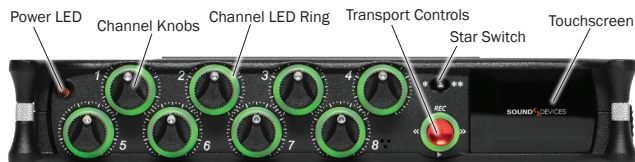

**FRONT**

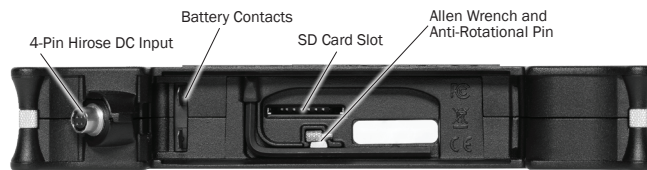

**REAR**



**LEFT**

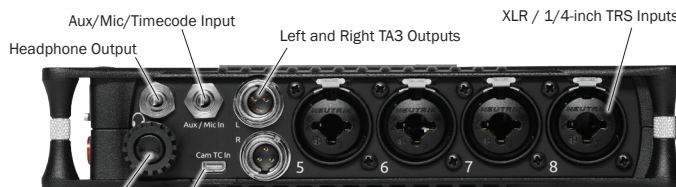

**RIGHT**

**POWER LED** Glows when the MixPre II is powered on.

**CHANNEL KNOBS** Sets the input gain for the channel. Press in on knob to access channel screen.

**CHANNEL LED RING** Provides visual indication of channel signal condition, solo and mute.

**TRANSPORT CONTROLS** A joystick (with its illuminated LED ring) on the front panel is used to perform various transport control functions. (see Transport).

**STAR (\* & \*\*) SWITCH** Provides a user-assignable hardware switch to frequently used functions. See Shortcuts.

**TOUCH SCREEN** The sunlight-viewable, high-resolution, touchscreen is used to navigate the MixPre II user interface.

**4-PIN HIROSE DC INPUT** Accepts DC voltages from 10–17 V for powering. [pin-4=+, pin-1=-] Works with included XL-WPH3.

**BATTERY CONTACTS** Accepts power sled accessories designed for MixPre II. Allows powering from AA or Sony L-Mount batteries, such as the included MX-8AA.

**ALLEN WRENCH & ANTI-ROTATIONAL PIN** Magnetically attaches to the MixPre II for safe keeping. Used to attach MixPre II to cameras and tripods via ¼-inch-20-thread captive screw on MixPre II top panel.

**SD CARD SLOT** Insert SD card for recording.

**INPUTS 1-8 FEMALE XLR / 1/4" TRS COMBO JACKS** Active-balanced analog microphone or line-level inputs. Inputs 1-4 on left panel, inputs 5-8 on the right. [pin-1 = ground, pin-2 = hot (+), and pin-3 = cold (-)].

**BNC TIMECODE OR WORD CLOCK OUTPUT** Menu-selectable between timecode or word clock functionality. Set to timecode to send LTC timecode to cameras, digi-slates or other timecode-enabled equipment. Set to word clock to use the MixPre-10 II as a master precision clock source for external equipment.

**BNC TIMECODE OR WORD CLOCK INPUT** Menu-selectable between timecode or word clock functionality. Set to timecode to receive LTC timecode from a camera or timecode generator. Set to word clock to sync to an external clock source.

**USB-A PORT**

1. USB keyboard.
2. Auto-copy to USB drives.
3. USB to approved 3rd party control surfaces.
4. USB hubs to support multiple devices.

**USB-C PORT** Used to connect to a computer for USB audio or transferring files from the SD card.

**X1/X2 OUTPUT** Unbalanced stereo 3.5 mm female connector. Routing determined in the Outputs menu. [Sleeve = ground, tip = X1, ring = X2].

**POWER SWITCH** Turns the power on and off.

**HEADPHONE OUTPUT** 3.5 mm TRS headphone output. Warning! This output can drive headphones to potentially dangerous levels. [Sleeve = ground, tip = left, ring = right]

**AUX/MIC/TIMECODE INPUT** Menu-selectable input. Accepts unbalanced stereo audio signal, Plug in Power microphones, or LTC timecode.

**HEADPHONE KNOB**

1. Rotate to control headphone volume.
2. Rotate to navigate some menus and the virtual keyboard. Press in to select items.

**HDMI TC INPUT** Connect to select cameras to receive HDMI timecode and record start/stop flags.

**LEFT & RIGHT TA3 OUTPUTS** +18 dBu line level outputs. Routing determined in the Outputs menu. [pin-1 = Ground, pin-2 = hot (+), pin-3 = cold (-). Float pin-3 to unbalance]

## Powering the MixPre II

Apply your choice of power source. Turn the master power switch located in the upper right corner of the left side panel to the On position. To ensure the battery/power status indicator displayed on the touchscreen shows accurate level and status, select your battery/power type in the Power menu.

When using AA batteries to power the MixPre II, we recommend Energizer Ultimate Lithium (not alkaline batteries). The high internal resistance of alkaline batteries makes them only suited to devices requiring low current (less than 25 mA), not higher power electronic devices such as the MixPre II.

Incorrect use of batteries poses a danger of explosion. Replace only with the same or equivalent type. Properly recycle batteries. Do not crush, disassemble, incinerate, dispose in a fire or expose batteries to high temperatures.

Save power by turning off unused channels.

With multiple options for powering, your MixPre II can operate in a wide array of applications and environments.

### **MIXPRE-3 II AND MIXPRE-6 II POWER OPTIONS**

1. Included MX-PSU AC wall adapter to USB-C power supply.
2. Four AA batteries installed in the included MX-4AA Battery Sled.
3. Eight AA batteries installed in the optional MX-8AA Battery Sled accessory.
4. One or two Sony-type L-Mount batteries installed in the optional MX-LMount battery sled accessory.
5. USB-C to USB-C cable (included) connected to a USB-C host computer or AC wall adapter.
6. USB-A to USB-C cable connected to a USB-A host computer or AC wall adapter. The unit will enter a low power state and some functionality will be limited with this power option.
7. MX-USBY Dual USB-A to USB-C optional accessory cable connected to a USB-A host computer. Use this cable option if your computer is unable to provide adequate power with only one USB-A port.

### **MIXPRE-10 II POWER OPTIONS**

1. Included XL-WPH3 AC to DC 12 V Power supply with 4-pin Hirose.
2. Eight AA batteries installed in the included MX-8AA Battery Sled.
3. One or two Sony-type L-Mount batteries installed in the optional MX-LMount battery sled accessory.

## Power Switchover and Priority

### **MIXPRE-3 II AND MIXPRE-6 II**

To preserve battery power, USB-C power sources take priority over batteries if both are connected with one exception - if the USB-C power source does not meet the full power requirements of the MixPre II, you can choose to power from battery or continue to power from USB-C. An underpowered MixPre II will be able to use two of the three or four channels with 48 V phantom mics. Other channels can still be used with dynamic mics and line level, Aux, or USB sources. In a low power state, the MixPre II automatically:

1. Dims LCD and LED Brightness.
2. Disables USB-A port.
3. Disables HDMI TC port.

For protection against accidental loss of power, the MixPre II incorporates circuitry to automatically switch over from USB-C to batteries.

### **MIXPRE-10 II**

For preservation of battery power, 4-pin Hirose power sources take priority over batteries if both are connected. For protection against accidental loss of power, the MixPre-10 II incorporates circuitry to automatically switch power sources.



# Touchscreen

The MixPre II has a sunlight-viewable, high-resolution, touch-screen-based user interface, which consists of the Home screen, Main Menu screen, and Channel screen views. There are several touch zones on the touch screen for controls. As you become familiar with the user interface, changing settings for inputs, outputs, recording and metering will become fast and intuitive.

## HOME SCREEN

The Home screen view appears on the touchscreen when the device is powered up.

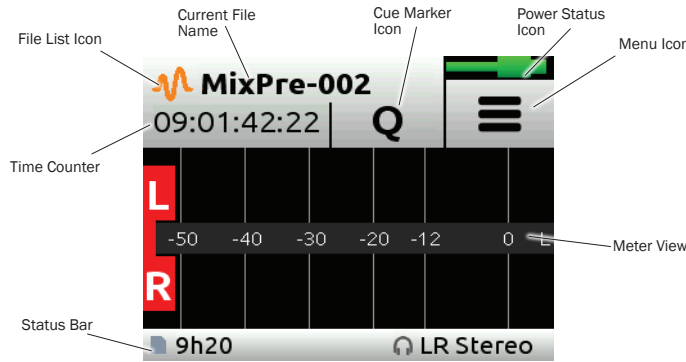

**FILE LIST ICON** Touch to enter the File List.

**CURRENT FILE NAME** Displays the current file name.

**TIME COUNTER** Displays current timecode value. If timecode is Off, displays time counter of recording file.

**CUE MARKER ICON** Touch to lay a cue marker during record or playback. Displays current cue mark point.

**POWER STATUS ICON** Displays the status of the active power source. See tables opposite for further details.

**MENU ICON** Touch to enter the setup menu.

**METER VIEW** Displays audio activity. Touch to toggle through available meter views:





1. Left and Right mix tracks.
2. Left and Right mix tracks with isolated tracks.
3. Left and Right mix tracks, USB inputs 1 and 2, and 2 camera returns (when Aux inputs are set to camera).

**STATUS BAR** Touch to toggle information displayed:



1. SD card status: card/drive activity, available recording time, file duration, elapsed time, and headphone preset.
2. USB drive status: remaining space on drive, sample rate, bit depth.
3. Sync Source (if external), sample rate, and bit depth.
4. Date and time.

While auto-copying, copy status is displayed on all status bars. Copy status will alternate with default info.

## MIXPRE-3 II AND MIXPRE-6 II

Power Status Icon	Description
 (Green USB)	USB power source is ideal.
 (Orange USB)	USB power source low. Brightness dimmed, HDMI & USB-A ports disabled, 48 V phantom on 2 channels only.
 (Green Battery)	Healthy battery. Plan to change batteries when green level drops to about ¼ full.
 (Flashing Red Battery)	Battery power is critically low. Change batteries.





## MIXPRE-10 II

Power Status Icon	Description
 (Green Battery)	Healthy battery. Plan to change batteries when green level drops to about ¼ full.
 (Flashing Red Battery)	Battery power is critically low. Change batteries.

# Transport Controls



## MIXPRE-3 II AND MIXPRE-6 II

The three Transport controls (illuminated buttons) on the front panel are used to perform recording and playback functions.

FUNCTION	CONTROL	ACTION
Record		Press to begin recording a new file. The button illuminates red while recording is underway. In Stop mode the record button flashes red while auto-copying to a USB thumbdrive.
Stop		While recording, press once to stop recording. While in playback, press once to stop playback. While in standby, press and hold to display next name. While in Standby and auto-copying is in progress, press Stop to optionally suspend auto-copying.
Play / Pause		Press to begin playback of the last file recorded or file currently loaded. The button illuminates green during playback. While in playback, press once to pause, and press again to resume playback. Whenever playback is paused, the button and the current file name will flash green.
Scrub		While playing or paused, press and hold the headphone encoder to enter Scrub mode. Then rotate clockwise for fast forward or counter-clockwise for rewind at speeds of 0x, 1/8x, 1/4x, 1/2x, 1x, 2x, 4x, 8x and 16x. The audio is heard in Scrub mode up to 2x speed.



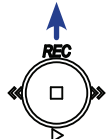
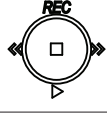
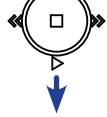
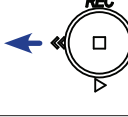
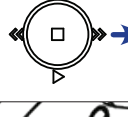

## MIXPRE-10 II

A joystick (with its illuminated LED ring) on the front panel is used to perform various transport control functions.

FUNCTION	CONTROL	ACTION
Record		Push up the Transport control to begin recording a new file. The LED ring illuminates red while recording is underway.
Stop		Press in the Transport control to stop recording or playback. While in standby, press and hold to display next take name. The LED flashes red while auto-copying to a USB thumbdrive. While in Standby and auto-copying is in progress, press Stop to bring up a dialogue box which gives the option to suspend auto-copying.
Play		Push down the Transport control to begin playback of the last file recorded or file currently loaded. While in playback, push down again to pause playback. The LED ring as well as the active file in the display will flash to indicate that Pause is active. Push down again to continue playback.
Rewind / Load previous take		While in standby, push left to load the previous take. While in playback, push and hold left to rewind.  When the MixPre is playing back or paused, moving the joystick to the left (<<) rewinds at 2x speed, then after holding for 5 seconds, it increases to 16x speed.
Fast forward / Load next take		While in standby, push right to load the next take. While in playback, push and hold right to fast forward.  When the MixPre is playing back or paused, moving the joystick to the right (>>) fast-forwards at 2x speed, then after holding for 5 seconds, it increases to 16x speed.
Scrub		While playing or paused, press and hold the headphone encoder to enter Scrub mode. Then rotate clockwise for fast forward or counter-clockwise for rewind at speeds of 0x, 1/8x, 1/4x, 1/2x, 1x, 2x, 4x, 8x and 16x. The audio may be heard in Scrub mode up to 2x speed.

## Navigating Menus

Most features and functions are selected and set up in the Menu.

ICON	FUNCTION
	Touch the Menu icon from the Home Screen to enter the Menu.
	Touch the Page (dots) icon to view the next page of options.
 BACK	Touch the Back icon to return to the main Menu from any submenu.
	Touch the Home icon to immediately return the the Home Screen.
LR Stereo 	Touch the Headphone icon to enter the Headphone menu.

### MAIN MENU SCREEN

Touch any menu item to enter the submenu. The menus available depend on model and Mode. See Choosing Your Mode for more information.

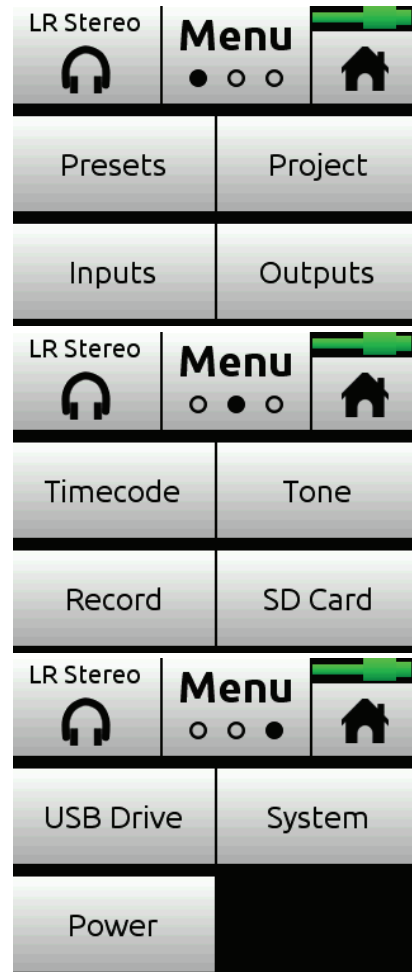

## Choosing your Mode

The MixPre II has three different modes of operation to suit you and your application: Basic, Advanced, and Custom. Basic mode is intended for simple, hassle-free, plug-and-play use and beginners. Advanced mode is for professionals and anyone who wants to have every available setting and option at their disposal. Custom mode allows you to select your own mixture of basic and advanced operation.

The MixPre-3 II and MixPre-6 II default to Basic mode. The MixPre-10 II defaults to Advanced mode. To change mode, go to Menu>System>Mode.

### MIXPRE-3 II BASIC VS ADVANCED

FEATURE	BASIC	ADVANCED
Gain	Channel knob controls all gain for a channel.	Dual gain stage. Input gain is set in the Channel Screen. Channel knob controls post-fade levels to mix bus.
Channel Screen Options	Pan (Left, Center, Right) Input Phantom Low Cut (On or Off)	Solo Mute Track Arm (Iso Tracks) Gain Pan (Variable) Input Phantom Low Cut (On or Off) Phase Delay NoiseAssist (requires NoiseAssist plugin) Stereo and MS Linking
Headphone Options	LR Stereo USB 1,2	LR Stereo LR Mono USB 1,2 Presets 1-4 Edit Presets Camera Stereo Camera Mono HP Solo mode (Multiple or Individual)
Outputs	Fixed routing of LR mix	Stereo Output flexible routing Stereo Output gain Stereo Out Mode (LTC or Audio) Stereo Out Mute L,R Delay USB Output 1-6
File List Options	Name Number Trash File Cue Move Cue Name Cue Delete	Undo Recording Name Number Notes Track Names Trash File Cue Move Cue Name Cue Delete
Aux In Options	Mic Line Timecode Off	Mic Line Timecode Camera Return Off
MixAssist	Not Available	Requires Plugin
NoiseAssist	Not Available	Requires Plugin
Record Options	Sample Rate fixed at 48 kHz Bit Depth fixed at 24 bit Records only the Left/Right mix Pre-roll Record Triggers Record Bells	Sample Rate Options 44.1 - 192 kHz Bit Depth options 16, 24, 32 (float) Record Isolated channels and mix tracks Individual control of Left and Right gain Individual control of Left and Right record arming Pre-roll Record Triggers Record Bells Remix & Rerecord NoiseAssist, Left and Right (requires plugin)

Limiters	Always On	Limiters (Off, Factory, Custom) Custom Limiter options (Ratio, Threshold, Release)
----------	-----------	---------------------------------------------------------------------------------------

### MIXPRE-6 II BASIC VS ADVANCED

FEATURE	BASIC	ADVANCED
Gain	Channel knob controls all gain for a channel.	Dual gain stage. Input gain is set in the Channel Screen. Channel knob controls post-fade levels to mix bus.
Channel Screen Options	Pan (Left, Center, Right) Input Phantom Low Cut (On or Off)	Solo Mute Track Arm (Iso Tracks) Gain Pan (Variable) Input Phantom Low Cut (On or Off) Phase Delay NoiseAssist (requires NoiseAssist plugin) Linking
Headphone Options	LR Stereo USB 1,2 USB 3,4	LR Stereo LR Mono USB 1,2 USB 3,4 Presets 1-4 Edit Presets Camera Stereo Camera Mono HP Solo mode (Multiple or Individual)
Outputs	Fixed routing of LR mix	Stereo Output flexible routing Stereo Output gain Stereo Out Mode (LTC or Audio) Stereo Out Mute L,R Delay USB Outputs 1-8
File List Options	Name Number Trash File Cue Move Cue Name Cue Delete	Undo Recording Name Number Notes Track Names Trash File Cue Move Cue Name Cue Delete
Aux In Options	Mic Line Timecode Off	Mic Line Timecode Camera Return Off
Ambisonics	Not Available	Requires Plugin
MixAssist	Not Available	Requires Plugin
NoiseAssist	Not Available	Requires Plugin
Record Options	Sample Rate fixed at 48 kHz Bit Depth fixed at 24 bit Records only the Left/Right mix Pre-roll Record Triggers Record Bells	Sample Rate Options 44.1 - 192 kHz Bit Depth options 16, 24, 32 (float) Record Isolated channels and mix tracks Individual control of Left and Right gain Individual control of Left and Right record arming Pre-roll Record Triggers Record Bells Remix & Rerecord NoiseAssist, Left and Right (requires plugin)
Tone Menu	On or Off	On or Off L Ident Tone Tone Level

<b>FEATURE</b>	<b>BASIC</b>	<b>ADVANCED</b>
Limiters	Always On	Limiters (Off, Factory, Custom) Custom Limiter options (Ratio, Threshold, Release)

**MIXPRE-10 II BASIC VS ADVANCED**

FEATURE	BASIC	ADVANCED
Gain	Channel knob controls all gain for a channel.	Dual gain stage. Input gain is set in the Channel Screen. Channel knob controls post-fade levels to mix bus.
Channel Screen Options	Pan (Left, Center, Right) Input Phantom Low Cut (On or Off)	Solo Mute Track Arm (Iso Tracks) Gain Pan (Variable) Input Phantom Low Cut (On or Off) Phase Delay NoiseAssist (plugin required) Stereo and MS Linking
Headphone Options	LR Stereo X1X2 Stereo USB 1,2 USB 3,4	LR Stereo LR Mono X1X2 Stereo USB 1,2 USB 3,4 Presets 1-4 Edit Presets Camera Stereo Camera Mono HP Solo mode (Multiple or Individual)
Outputs	Fixed routing of LR mix	L,R and X1,X2 flexible routing L,R and X1,X2 gain L,R and X1,X2 Out Mute L,R and X1,X2 Delay USB Outputs 1-12
File List Options	Name Number Trash File Cue Move Cue Name Cue Delete	Undo Recording Name Number Notes Track Names Trash File Cue Move Cue Name Cue Delete
Aux In Options	Mic Line Timecode Off	Mic Line Timecode Camera Return Off
Ambisonics	Not Available	Requires Plugin
MixAssist	Not Available	Requires Plugin
NoiseAssist	Not Available	Requires Plugin
Record Options	Sample Rate fixed at 48 kHz Bit Depth fixed at 24 bit Records only the Left/Right mix Pre-roll Record Triggers Record Bells	Sample Rate options 44.1 - 192 kHz Bit Depth options 16, 24, 32 (float) Record Isolated channels and mix tracks Individual control of Left and Right gain Individual control of Left and Right record arming Pre-roll Record Triggers Record Bells Remix & Rerecord NoiseAssist, Left and Right (requires plugin)



<b>FEATURE</b>	<b>BASIC</b>	<b>ADVANCED</b>
Tone	On or Off	Flexible Tone Routing Tone Level L Ident Tone Tone Level
Limiters	Always On	Limiters (Off, Factory, Custom) Custom Limiter options (Ratio, Threshold, Release)

## Custom Mode

Custom mode allows you to select your own mixture of basic and advanced operation. This mode grants access to select categories of Advanced Mode.

### CONFIGURE CUSTOM SETUP

1. Set System > Mode to Custom.
2. In System > Custom Setup set each category to basic or advanced.

Custom Setup options are:

CATEGORY	DESCRIPTION
Channel	Allows advanced operation of the following items: Channel Solo, Mute, Track Arm, Pan, Low Cut, Phase, Delay, NoiseAssist (requires plugin), Channel Linking, and isolated track recording.
Gain	Allows advanced operation of channel gain, including dual gain stage (gain and fader) and Remix.
Headphone	Allows access to advanced headphone presets and channel solo.
Record	Allows advanced operation of isolated track arming and recording, LR track linking and gain, sample rate, and bit depth.
Metadata	Allows advanced operation in the File List. This includes metadata entry and editing of name, number, notes, track names, and access to the undo recording feature.
Outputs	Allows advanced operation of Output menu items such as mute, gain, mode, and routing.

## Channel Screen - Basic Mode

The MixPre II's flexibility is enhanced by its ability to select various input types to its mixer channels. On the MixPre-3 II, channels can be sourced from XLR mic/line input, 3.5 mm Aux line or mic input, or from USB channels. On the MixPre-6 II and MixPre-10 II, channels can be sourced from XLR or TRS mic/line input, 3.5 mm Aux line or mic input, or from USB channels.

Access the channel's input settings by pushing in the channel's knob. There are three channel inputs on the MixPre-3 II, 6 channel inputs on the MixPre-6 II, and 10 channel inputs on the MixPre-10 II.

Channels 5 and 6 on MixPre-6 II and 9 and 10 on the MixPre-10 II are controlled in the Inputs menu. Input source, gain, pan, and low-cut are all available in this menu.

Channels use a single gain stage adjusted by the knob. Levels set at the channel knob are sent to the LR mix record channels and the LR outputs. Limiters are present on each channel and the LR mix bus and will ensure that your audio is safe from accidental clipping.

**PAN** Pan the channel's signal Left, Center or Right in the stereo LR mix and Stereo Out.

**LOW CUT** Turn Low Cut filter on or off. Useful for reducing unwanted low frequency in the audio of the select channel. In Basic Mode Low Cut is fixed at 80 Hz.

**INPUT** Select one of the available Mic, Line, Aux (available when Aux In Mode is Mic or Line) or USB inputs as the channel source.

**PHANTOM** Turn on 48 V phantom power when using a condenser microphone in the selected channel (available when Input is Mic).

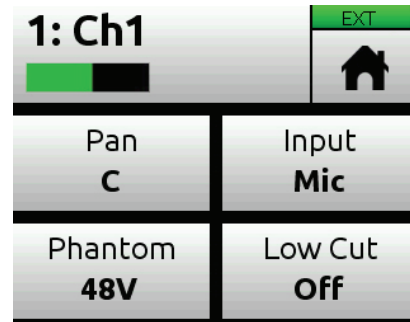

## Channel Screen - Advanced Mode

The MixPre II's flexibility is enhanced by its ability to select various input types to its mixer channels. On the MixPre-3 II, channels can be sourced from XLR mic/line input, 3.5 mm Aux line or mic input, or from USB channels. On the MixPre-6 II and MixPre-10 II, channels can be sourced from XLR or TRS mic/line input, 3.5 mm Aux line or mic input, or from USB channels.

Access the channel's input settings by pushing in the channel's knob. There are three channel inputs on the MixPre-3 II, 6 channel inputs on the MixPre-6 II, and 10 channel inputs on the MixPre-10 II.

Channels 5 and 6 on MixPre-6 II and 9 and 10 on the MixPre-10 II are controlled in the Inputs menu. Input source, solo, mute, arm, gain, pan, low cut, and linking are all available in this menu.

Channels use a dual gain stage. Adjust the gain control in the Channel Screen and fader level with the knob. Limiters are present on each channel and the LR mix bus and will ensure that your audio is safe from accidental clipping.

**SOLO** Lets you "solo" the selected channel in the headphone output. Solo mode can be set to "Individual" or "Multiple" in the HP menu. When a channel is soloed, the LED ring will flash orange.

**MUTE** Provides quick access to muting an input.

**ARM** Allows pre-fade recording of the channel to an individual track on the SD card.

**GAIN** Sets the sensitivity of the input. Generally, the Gain should be set so that the loudest parts of the audio signal just touch the red segments of the meters. The control knobs on the front panel act as faders.

**PAN** Lets you position the audio of the channel anywhere between Left and Right in the stereo image of the LR mix and Stereo Out.

**LOW CUT** Turn Low Cut filter on or off. Useful for reducing unwanted low frequency in the audio of the select channel. Frequency is adjustable from 40, 80, 120, or 160 Hz.

**INPUT** Select one of the available Mic, Line, Aux (available when Aux In Mode is Mic or Line) or USB inputs as the channel source.

**PHANTOM** Turn on 48 V phantom power when using a condenser microphone in the selected channel (available when Input is Mic)

**PHASE** Phase inversion (or polarity reversal) is used to compensate for incorrectly wired, balanced cables, to prevent signal cancellation when a source is dual-mic'd from opposite directions, or to reverse left/right with microphones in a mid-side (MS) configuration.

**DELAY** Input delay may be used to compensate for 'phases' sounding audio because of time-of-arrival differences between sound sources, such as a boom mic and wireless radio mic picking up the same sound source.

**NOISEASSIST (REQUIRES PLUGIN)** Sets the amount of noise suppression applied to a channel. Adjust from 0 dB (no suppression) to -20 dB (maximum suppression) in 1 dB steps. Only available when the channel is selected in the System > NoiseAssist menu.

**LINKING** All MixPre II's can link channels 1 and 2 either as a stereo pair, mid side pair, or turn linking off.

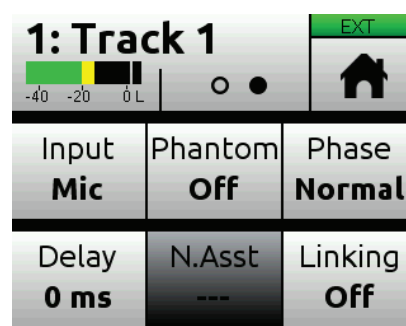

Input Types	Description
Mic	Use for microphones. For condenser mics requiring 48 V phantom power, set Phantom to On.
Line	Use this type for balanced analog line level sources.
Aux In 1-2	Use for unbalanced stereo input.
USB	Use for sources coming from a computer via USB-C.

## Linking Channels

Are you working with a stereo source—a keyboard or stereo mic perhaps? To make it easy to adjust these types of sources, the MixPre II offers linking of channel pairs either as a stereo pair or mid-side (MS) pair.

### **STEREO PAIR LINKING**

Control the level of both channels 1 and 2 with the Channel 1 knob. The Channel 2 knob will now function as a balanced control if stereo linked.

### **MS PAIR LINKING**

Control the level of both channels 1 and 2 with the Channel 1 knob. The Channel 2 knob will now function as a width control. You can choose to have the MS decoder apply to the mix only and not isolated tracks in the menu Inputs > MS Decode.

### **MULTICHANNEL LINKING**

When multiple channels are linked, gain, fader, limiters, track arming, low cut filters, and input delay are all linked and controlled from the single Channel. Additionally, the Link Type menu provides the options for which parameters are linked.

All links input type, trim gains, faders, limiters, low cuts, record arms, and delays

Faders Only links only fader level.

The MixPre-6 II can link channels 1-3 and 1-4.

The MixPre-10 II can additionally link channels 1-3, 1-4, 1-5, 1-6, 1-7 and 1-8.

### **GAIN STAGING WITH LINKING**

You can use linking with single gain stage or two-gain stage (trim/fader) operation. For instance, users wanting to link inputs 1-2 or 1-4, but control all levels from the front-panel Channel 1 knob should set System > Mode to Custom and then in Custom Setup, set Gain to Basic and Channel to Advanced.

Users wanting to link those same inputs but use two gain stages should use Advanced Mode or Custom mode with both Gain and Channel set to Advanced. Then, you can adjust trim gain levels for linked channels from the Channel 1 screen and adjust fader levels for linked channels with the Channel 1 knob.

# Inputs Menu

The Inputs menu allows you to access software-controlled channels (5/6 on MixPre-6 II and 9/10 on MixPre-10 II) and Aux In Mode settings.

**SOFTWARE-CONTROLLED CHANNEL SCREENS** Selects Input source from Off, USB 1 or 2, USB 3 or 4 (MixPre-6 II and MixPre-10 II only) and Aux In. From these screens, you may also solo, mute, arm tracks, adjust gain, pan, low cut, and set linking.

**AUX IN MODE** Configures how the Aux/Mic In 3.5 mm connector is used.

1. Mic: Select this option when the Aux/Mic In is to be used with a mic. The MixPre II provides bias voltage for PiP (plug-in-power) mics. Aux 1 and 2 are available as input sources to any channel.

2. Line: Select this option when the Aux/Mic In is to be used with an unbalanced 2ch line source, such as smartphone headphone output, stereo line source, etc. Aux 1 and 2 are available as input sources to any channel.

3. Camera: Select this option when the Aux/Mic In is to be used for monitoring a video camera's audio output via the MixPre II's headphones and camera return (C1/C2) meters located on meter view. This is particularly useful when you want to use the MixPre II to drastically improve the sound quality recorded on the camera. It is common knowledge that camera mic inputs are not of high quality so by connecting your mics to the MixPre II instead, then connecting the MixPre II's L/R outputs to your camera audio input, you will achieve far superior sound quality. Then by connecting the camera's audio output to the MixPre II's Aux/Mic In, it allows you to check that the camera audio is noise and distortion-free.

When this option is selected an additional setting appears in the Input Menu called Camera Gain. This lets you adjust the gain of the incoming camera audio level. You also get additional camera monitoring options in the HP Presets menu.

When Aux In Mode is set to Camera, you cannot route Aux In to a channel and thus you cannot record it.

4. Timecode: Select this option is for using an external timecode source connected to the Aux/Mic In port. The 3.5 mm TRS connector is wired to receive timecode on its tip. Also ensure Menu > Timecode > TC Mode is set to Aux TC In.

Off: Select this option to turn off the Aux/Mic Input.

**MS DECODE**

Choose between ISOs & Mix and Mix Only.

**KNOB PRESS**

Selects the behavior of pressing a Channel Knob. Available in Advanced Mode.

1. Ch.View: Pressing the channel knob enters the channel view. Channel Gain is automatically selected upon entry.

2. Ch.View + Solo: Pressing the channel knob enters the channel view and automatically solos the channel. Channel Gain is automatically selected upon entry.

*Setting Knob Press to Ch.View + Solo does not permit multiple HP Soloing. HP Solo mode is automatically set to 'Individual' if it was previously set to 'Multiple'*

**AMBISONICS**

MixPre-6 II and MixPre-10 II only. Requires plugin; see separate Ambisonics guide for more information.

**MIXASSIST**

Requires plugin. MixAssist is not available in Music or Ambisonics mode. See separate MixAssist guide for more information.

**NOISEASSIST**

Requires plugin. NoiseAssist is not available in Music or Ambisonics mode. See separate NoiseAssist guide for more information.

# Metering

There are five basic methods for observing input and output levels on the MixPre II.

**CHANNEL KNOB RING LEDS** The brightness of the light ring indicates the level of the input. Green = signal present, red = signal peaking, orange = signal limiting. A channel's ring LED will flash orange when in solo and glow red when the channel is muted. With MixAssist active, the ring LED will flow solid green to indicate that channel is active.

**CHANNEL SCREEN METER** The Channel screen displays the isolated channel meter in the top left-hand corner.

**HOME SCREEN METERS** To switch meter views, touch the meters to cycle through the three different views. The meters show signal levels, current arm status of each track, limiter activity, MixAssist active channel status, and NoiseAssist suppression amount.

## METERING BALLISTICS

Audio meter ballistics is the manner in which a visual meter responds to audio signal levels. Peak-reading ballistics correspond to actual signal peaks, but do not necessarily correspond to perceived signal loudness. Peak meters have an instant attack and slow decay and are useful in digital audio workflows where signal overload can cause immediate distortion. Volume Units (VU) meter ballistics correspond closely to how the human ear perceives loudness. VU meters provide good visual indication of how loud a signal will be, but provides poor information of actual signal peaks.

The MixPre II uses a combination Peak+VU ballistics for all meters, where the perceived loudness (or VU) is simultaneously displayed as a standard bar while the peak signal is displayed as a single, independent segment above the VU.

CHANNEL SCREEN METER



MAIN LR STEREO METER VIEW



LR, ISO MULTI-TRACK METER VIEW (MIXPRE-10 II SHOWN)

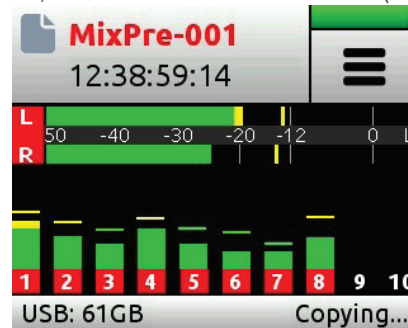

LR, CAMERA RETURNS, AND USB 1,2 METER VIEW





## Limiters

The MixPre II has fully adjustable limiter parameters giving control over Ratio, Release and Threshold. The limiters can be fine tuned for dialog, foley, nature recording, and even live instruments. Access the Limiters menu by navigating to Menu > System > Limiters.

The following options are available in the Limiters menu:

**ON/OFF** Toggles the Limiters On or Off. While set to On the limiter is a global setting and applies to every channel.

**LIMITER SETUP** Toggle limiter preset between Factory or Custom.

**CUSTOM** Enters Custom Limiter set up menu giving the following parameter adjustments:

**RATIO** Sets the Limiting ratio. Options are Inf:1, 10:1, and 20:1. 20:1 is the default setting.

**RELEASE** Adjustable from 50-1000 ms in 10 ms increments. 100 ms is the default setting.

**THRESHOLD** adjustable from -2 to -12 dBFS in 1 dB steps. -6 dBFS is the default setting.

Any changes made in Custom Limiter mode are retained after leaving the menu, allowing you to compare the Factory setting and your own Custom Limiter setting.

Limiters are disabled in 32-bit float mode.

# Outputs

The MixPre II features multiple Output configurations for flexible recording scenarios. The Outputs menu is available in Advanced mode. In the Outputs menu, you may send any channel, Aux input, USB input or LR mix to either the outputs, mute outputs, and control gain. The MixPre-3 II and MixPre-6 II Stereo Out can be configured to send audio or LTC timecode.

**MIXPRE-3 II & MIXPRE-6 II:**

**STEREO OUT MUTE** Mutes the output.

**STEREO OUT GAIN** Adjusting output gains is useful for optimizing the level feeding downstream devices such as transmitters, external mixers, PA, etc. The level of the output can be set to Off, 40 to +20 dB in 1 dB steps.

**STEREO OUT LEFT OR RIGHT** Configures output source, select from Mix L, Mix R, Isolated Channels (pre or post-fade), Aux In, or USB streaming into the MixPre II from a computer.

**LEFT, RIGHT OUTPUT DELAY** Output delay is particularly useful when sending audio to video operators on a production set or in live streaming applications to ensure that audio is in sync with video. Outputs can be delayed from 0 to 400 ms. Delay applies to the Stereo Out left and right and any USB output routed from Out L or R.

**STEREO OUT MODE** Configures the output to be used as an LTC timecode or audio output.

**STEREO OUT LEFT OR RIGHT** Configures output source, select from Mix L, Mix R, Isolated Channels (pre or post-fade), Aux In, or USB streaming into the MixPre II from a computer.

**USB 1-6 (MIXPRE-3 II)** Configures output source from L,R, 1-3 (pre- or post-fade), Headphone L, R, or Output L,R.

**USB 1-8 (MIXPRE-6 II)** Configures output source from L,R, 1-6 (pre- or post-fade), Headphone L, R, or Output L,R.

**MIXPRE-10 II:**

**L/R OUT MUTE** Mutes the output.

**X1/X2 OUT MUTE** Mutes the output.

**L/R GAIN** Adjusting output gains is useful for optimizing the level feeding downstream devices such as transmitters, external mixers, PA, etc. The level of the output can be set to Off, 40 to +20 dB in 1 dB steps.

**X1/X2 GAIN** Adjusts the level of the output from Off, 40 to +20 dB in 1 dB steps.

**LEFT OR RIGHT OUTPUT** Configures output source, select from Mix L, Mix R, Isolated Channels (pre or post-fade), Aux In, or USB streaming into the MixPre II from a computer.

**LEFT, RIGHT, X1, X2 OUTPUT DELAY** Output delay is particularly useful when sending audio to video operators on a production set or in live streaming applications to ensure that audio is in sync with video. Outputs can be delayed from 0 to 400 ms. Delay applies to the left, right, X1 and X2 outputs and any USB output routed from Out L, R, X1, or X2.

**USB 1-12** Configures output source from L,R, 1-10 (pre- or post-fade, Headphone L, R, or Output L,R, X1,X2).



**TO ROUTE THE L/R AND X1/X2 STEREO OUTPUTS:**

1. Tap .
2. Tap Outputs.
3. Select any of the following:
  - L Output
  - R Output
  - X1 Output
  - X2 Output
4. From the routing matrix, select what channel to send to the output.

In addition, if you choose to send the channels to outputs, you can select either pre-fade (Channel knob has no effect) or post-fade (Channel knob controls level).

# Headphone Out

The MixPre II's high quality headphone amplifier provides high power and very low noise performance so that you can accurately hear the audio, regardless of headphones or environment.

Connect headphones via 3.5 mm jack to the headphone jack (located on the right side panel). The volume of the headphones is set using the knob directly adjacent to the headphone jack.

The headphone amplifier is capable of very high output levels. Please use caution when wearing headphones as hearing damage could result with inappropriate volume levels.

When clipping occurs in the headphones, the Headphone Clip indicator appears in the top right corner of screen, over the Power Status indicator.



## ACCESS THE HEADPHONE PRESET MENU

1. Enter the main menu.
2. Tap  in the upper left hand corner.
3. Above this icon, the currently selected HP preset is displayed.

## ADVANCED MODE - CREATING A CUSTOM HP PRESET

Select Edit HP Preset (Advanced Mode Only) to edit and name any of the User HP Presets.

## ADVANCED MODE - HP SOLO

HP Solo mode provides options for single or multi-channel solo monitoring. Soloing channels is performed in the channel screens.

## DISABLING RECORD BELLS IN HEADPHONES

Record bells, heard in headphones when recording is started and stopped, may be turned off. The record bells can be turned off in the Record menu.

## PRESET OPTIONS BY MODEL

### MIXPRE-3 II

Basic Mode: LR Stereo, USB 1, 2, Advanced Mode: LR Stereo, LR Mono, USB 1, 2, and User Presets 1-4  
Camera options appear when Aux In is set to Camera.

### MIXPRE-6 II

Basic Mode: LR Stereo, USB 1, 2, USB 3,4  
Advanced Mode: LR Stereo, LR Mono, USB 1, 2, and User Presets 1-4  
Camera options appear when Aux In is set to Camera.

### MIXPRE-10 II

Basic Mode: LR Stereo, X1X2 Stereo, USB 1,2, USB 3,4, and User Presets 1-4.  
Advanced Mode: LR Stereo, LR Mono, X1X2 Stereo, USB 1,2, USB 3,4, and User Presets 1-4.  
Camera options appear when Aux In is set to Camera.

## Front Panel Locks

All MixPre mixer-recorders can lock the front panels controls to prevent accidental adjustments.

Press channel knobs 1, 2 and 3 simultaneously to enter the Front Panel Menu.

**TRANSPORT** Locks or unlocks transport controls on the MixPre. (Locked, Unlocked\*)

**MIXPRE-3 II**  
Play, Stop, Record, and scrub mode on headphone knob. (Locked, Unlocked\*)

**MIXPRE-6 II**  
Play, Stop, Record, scrub mode on headphone knob, and the \* shortcut. (Locked, Unlocked\*)

**MIXPRE-10 II**  
All joystick controls (record, stop, play, rewind, ff), and \*/\*\* toggle. (Locked, Unlocked\*)

**TOUCHSCREEN** Locks or unlocks all touch activity of the LCD for all models. (Locked, Unlocked\*)

**CH. KNOBS** Locks or unlocks the front panel gain knobs from making level adjustments and entering the channel screens for all models. (On, Off\*)

**HP KNOB** Locks or unlocks headphone knob press and rotate functions. (Locked, Unlocked\*)

If any parameter change is attempted while locked, a popup will appear. Enter the Front Panel Menu and toggle that parameter option Off to regain control of that parameter.

Controls from the Wingman application, USB keyboard or USB MIDI controllers are unaffected by Front Panel Lock Mode.

All Front Panel functions are unlocked when the MixPre is rebooted.

Front Panel	
← Back	
Transport <b>Unlocked</b>	Touchscreen <b>Unlocked</b>
Ch. Knobs <b>Unlocked</b>	HP Knob <b>Unlocked</b>

# Using the MixPre II as a USB Audio Interface

The MixPre II Series perform as highly capable and pristine quality USB audio interfaces. They support up to 96 kHz sample rate at bit depths of 16, 24, 32-bit integer or 32-bit float. The MixPre II's 32-bit float USB audio path makes it possible to record into a DAW above 0 dBFS without clipping.

A list of compatible 32-bit float OS and DAW's can be found at [www.sounddevices.com/32-bit-float-applications](http://www.sounddevices.com/32-bit-float-applications)

For PC users, the MixPre-6 II and MixPre-10 II will appear as a 2x2 audio interface unless a specific ASIO® driver is installed. The latest ASIO drivers are available for free at [www.sounddevices.com/download](http://www.sounddevices.com/download)

A PC running Windows 10 or higher is required to stream 32-bit float audio. A PC running Windows 7 or below will not stream audio at 32-bit float. Please install the correct ASIO driver relative to your operating system.

To work with the USB audio from a host computer, it is necessary to route the USB 1 - 4 sources appropriately. To mix the USB audio from the host computer with live audio from the inputs to the LR bus, use the channel screen and select input source. To hear the USB host computer audio in the headphones only, switch the HP preset to USB 1,2 or USB 3,4.

The MixPre II is capable of recording and streaming audio to a USB host simultaneously, or recording the USB audio stream out of a computer directly to its SD recorder.

**LOW-LATENCY MONITORING** Latency has been minimized while using the MixPre-II as a USB interface. In situations where the throughput latency is higher than desired, the input can be directly monitored in the headphone output.

## **TO MONITOR WITH ZERO-LATENCY:**

1. Connect via USB-C to the USB port on your computer.
2. Confirm that the LR Stereo HP Preset is selected.
  - Select USB 1 for Channel 1 source (MixPre-3 II), Channel 5 source (MixPre-6 II), or Channel 9 source (MixPre-10 II) and Pan L.
  - Select USB 2 for Channel 2 source (MixPre-3 II), Channel 5 source (MixPre-6 II), or Channel 10 source (MixPre-10 II) and Pan R.

OR

- Create a custom HP preset that mixes the microphone or input you want to record from with the USB 1 and/or USB 2 feed from the computer. For example, HP L = Ch1 + U1 and HP R = Ch1 + U2.
3. Connect microphone or other inputs to remaining channels.
  4. Select USB 1 for Channel 1 source (MixPre-3 II), Channel 5 source (MixPre-6 II), or Channel 9 source (MixPre-10 II) and Pan L.
  5. Select USB 2 for Channel 2 source (MixPre-3 II), Channel 5 source (MixPre-6 II), or Channel 10 source (MixPre-10 II) and Pan R.

6. Connect microphone or other inputs to remaining channels.
7. Select the appropriate inputs for remaining channels.
8. Setup your DAW software for a new track with its source being any of the available channels.
9. Disable record monitoring or mute the channel's output in the DAW.
10. You should now be able to hear and adjust the output of your DAW audio through the channels you set to USB 1 and 2 on your MixPre while adjusting your low-latency feed in your headphones (and send levels to DAW) using the remaining channel knobs.

## USB Output Routing

Each of the MixPre's USB audio output streams can be sourced from any channel (pre- or post-fade), LR mix bus, headphone output or LR output and X1,X2 (on the MixPre-10 II only).

### MIX-MINUS SENDS

A mix-minus send is used when working with remote contributors in podcasting, conferencing and broadcast applications. It allows the remote contributor to hear the program mix, minus their own voice, the remove distracting latency.

### TO SETUP UP A MIX-MINUS SEND:

1. In the Outputs>St.Out Left or St.Out Right menus (or L, R, X1, or X2 Output menus on the MixPre-10 II), create a summed mix of all the channels you want to send to the remote contributor minus their own channel. You can mix the channels pre-fade or post-fade.
2. Select the Output you have configured in step 1 as the source for the USB channel you are sending to the remote contributor.

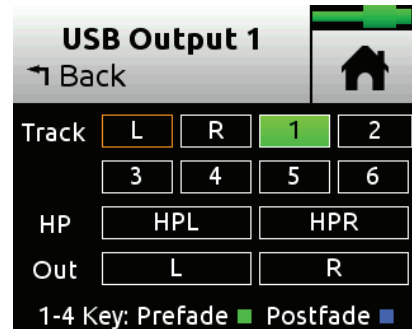
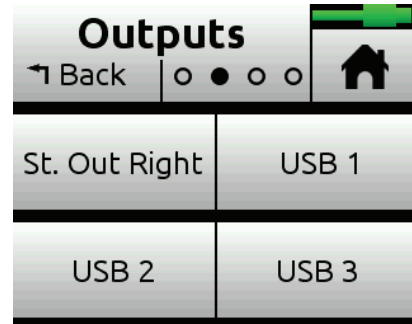



# System

**MODE** Switch between Basic, Advanced and Custom.

**FILE TRANSFER** Transfer files between the MixPre and a host computer.

**USB AUDIO** Switch between Normal or Stereo Out. When set to Stereo Out, the USB Audio interface outputs only and does not receive USB audio from a computer.

**USB-C (MIXPRE-3 II AND MIXPRE-6 II ONLY)** Switch between Power only or Audio when using with a USB-C power or audio source.

**LIMITERS** Set limiters to off, factory, or custom.

**BLUETOOTH** Switch Bluetooth on/off.

**NOISEASSIST (PLUGIN REQUIRED)** Activate and setup Noise-Assist routing.

**WINGMAN PASSWORD** Set a required password for the Wingman app.

**BRIGHTNESS** Adjust the brightness of the touch screen and the ring LEDs.

**DATE/TIME**

Set current date/time and format.

**TUNE CRYSTAL (MIXPRE-10 II ONLY)** Fine tune the internal crystal frequency to an external word clock or LTC signal via BNC In.

**REGULATORY** Provides full Federal Communications Commission (FCC) compliance information.

**VERSION** Provides the model type, current firmware version, and serial number.

**UPDATE FIRMWARE** Update the firmware from a file on the SD card. The latest firmware can be downloaded from the Sound Devices website: [www.sounddevices.com/support/downloads](http://www.sounddevices.com/support/downloads)

While updating firmware, power the MixPre via:

USB-C on the Mixpre-3, -3M, or -3 II

USB-C on the MixPre-6, -6M, or -6 II

When powering via USB-C from a computer, it is best to set Menu>System>USB-C to Power Only.

Use the included Hirose power supply for the MixPre-10T, -10M, or -10 II.

Fully charged batteries are also acceptable on all models.

Do not perform the update with low batteries or unstable power sources.

*When upgrading to firmware version 7.0 or higher from any version lower than 6.0 the firmware installation process will need to be completed twice. After the first installation is complete, the MixPre II will prompt you to start the second installation process.*

**PLUGINS** View and apply plugins. Plugins enhance the capability of your MixPre are available to purchase at: [store.sounddevices.com](http://store.sounddevices.com)

# Formatting Media

SD cards must be formatted by the MixPre II for reliable recording and playback. Back-up any wanted audio recordings or data on the SD card before formatting. The formatting process erases all data on the SD card.

If a USB thumbdrive is inserted into the USB A port, the MixPre II automatically copies the current project's recorded files to it. The thumbdrive must also be formatted before use.

We highly recommend using Sound Devices branded SD cards as these have been optimized to provide the best performance. If these are not available, most reputable manufacturers' cards (such as SanDisk or Delkin) that meet or exceed class 10 speeds are acceptable. Similarly, we highly recommend only using Sound Devices' approved USB thumbdrives to ensure reliable operation. Current approved media can be found [here](#).

All media will be formatted as exFAT. If any media is formatted differently, the MixPre will display a formatting reminder. The exFAT file system is not compatible with Windows XP or Mac OS X 10.6.4 and lower.

## FORMAT AN SD CARD

1. Insert an SD card in the slot located on the rear panel.
2. Navigate to SD Card > Edit > Format.
3. When asked to confirm the command to format the card, touch OK.

## FORMAT A USB THUMBDRIVE

1. Connect a USB ThumbDrive to the USB-A port located on the left panel or USB hub.
2. Navigate to USB Drive > Edit > Format.
3. Confirm the command to format the card, and touch OK.

## USB AUTO-COPY

The MixPre II will auto-copy to a formatted USB-A thumbdrive when inserted directly into the USB-A port or when using a USB hub. Stopping a recording will automatically copy the last recorded file to the thumbdrive. While copying, the record button on the MixPre-3 II and MixPre-6 II and the ring LED on the MixPre-10 II will flash while the process is being completed. The completion rate will display as a percentage on the bottom right corner of the status bar. If a new recording is started while auto-copying is still in progress, auto-copying will still continue.

## INTERRUPTING USB AUTO COPY WITH POWER CYCLE

Auto-copy can be temporarily suspended during longer copying times. During auto-copy in stop mode, pressing stop or toggling the power switch to OFF brings up the following popup:

"Suspend USB auto-copy? Copying will resume when record is next pressed. OK, Cancel"

If "OK" is pressed, Auto-copying is suspended and will resume copying when record is next pressed.

If "Cancel" is pressed, Auto-copying will continue until complete then power down if switch is off or sit in idle if power switch is on.

While the MixPre II is auto-copying, the USB Drive and SD Card menu are unavailable.



## Record - Basic Mode

**PRE-ROLL TIME** Pre-roll captures audio for a set amount of time before Record is pressed, ensuring important audio is never missed. Pre-roll time decreases as sample rate increases. Choose up to 10 seconds of pre-roll at 48 kHz. At 96 kHz pre-roll is limited to a maximum of 5 seconds. At 192 kHz pre-roll is limited to a maximum of 2 seconds. Pre-roll is not available in record run mode or when using a record trigger.

**REC TRIGGER** Sets record triggering from either timecode, HDMI flag or HDMI FUJIFILM flag. The default is Off.

**RECORD BELLS** Enable or disable record bell notifications. Record bells are On by default.

## Record - Advanced Mode

**REC L, R** Arms L and/or R mix buses. Choose between Off, Off & Linked, L, R, L&R, and L&R Linked.

**L GAIN** Sets the gain for the L mix.

**RIGHT GAIN** Set the gain for the R mix. This setting is disabled when Rec L,R Mix is set to LR Linked.

**SAMPLE RATE** Set the internal sample rate and sample rate of recorded WAV files. Choose between 44.1 kHz, 47.952 kHz, 48 kHz, 48.048 kHz, 96 kHz, and 192 kHz.

**BIT DEPTH** Select between 16, 24, and 32 float bit depth.

**PRE-ROLL TIME** Pre-roll captures audio for a set amount of time before Record is pressed, ensuring important audio is never missed. Pre-roll time decreases as sample rate increases. Choose up to 10 seconds of pre-roll at 48 kHz. At 96 kHz pre-roll is limited to a maximum of 5 seconds. At 192 kHz pre-roll is limited to a maximum of 2 seconds. Pre-roll is not available in record run mode or when using a record trigger.

**REC TRIGGER** The MixPre II may be configured to begin recording when it is triggered. Setting the Record Trigger to HDMI flag will initiate record when a compatible device issues the record flag via the HDMI input. The MixPre II has two HDMI rec trigger options. HDMI flag for Sony, Panasonic, Nikon, Canon and Blackmagic cameras and HDMI FUJIFILM for FUJIFILM cameras. Setting the Record Trigger to Timecode will initiate record when the MixPre II detects running LTC timecode via the Aux or BNC inputs (MixPre-10 II only). Set record triggers in the Record Menu. When record triggers are used, Pre-roll is disabled.

**REMIX** Allows you to simultaneously play back a file and record a new L/R mix while adjusting the gains with the fader knobs. To remix a recording, turn on Remix in the Record menu. Select a file from the File List that has isolated tracks and select Remix.

*Tip: Enable MixAssist with remixing/re-recording to help clean up audio and reduce background noise in an existing recording.*

**LEFT N.ASST (PLUGIN REQUIRED)** Sets the amount of Noise-Assist suppression on the L mix track. Adjust from 0 dB (no suppression) to -20 dB (maximum suppression) in 1 dB steps. Option is only available when L is selected in the System > NoiseAssist menu.

**RIGHT N.ASST (PLUGIN REQUIRED)** Sets the amount of Noise-Assist suppression on the R mix track. Adjust from 0 dB (no suppression) to -20 dB (maximum suppression) in 1 dB steps. Option is only available when R is selected in the System > NoiseAssist menu.

**RECORD BELLS** Enable or disable record bell notifications. Record bells are On by default.

## File Splits

To conform to the Broadcast WAV File standard, the maximum size of a file recorded by the MixPre II is 4GB. If a recording exceeds this limit, the MixPre II will automatically begin recording a new file. The recording process is seamless, meaning the two files can be joined together in post with no loss in audio.

# Timecode

When timecode is enabled, it is displayed on the home screen beneath the current filename. Standard timecode is displayed as HH:MM:SS:FF. Drop-frame timecode is displayed with a semi-colon between the seconds and frames fields: HH:MM:SS;FF.

Each time you press record, the current timecode value is stored inside the Broadcast WAV file. Most popular video editing applications can read this timecode value to help sync the audio with picture.

When power is removed, the internal battery maintains accurate timecode for up to 4 hours. An alert will be issued whenever the timecode generator (in Free Run and Time of Day timecode modes) has reset due to internal battery depletion. This internal battery is automatically charged anytime the MixPre II is powered on.

**TC MODE** Select between Free Run, Time of Day, Rec Run, BNC In (MixPre-10 II only), Aux In 1, Aux In 2, HDMI TC In, HDMI FUJIFILM or Off.

**FRAME RATE** Select between 23.98, 24, 25, 29.97nd, 29.97dF, 30, and 30 dF. Setting the frame rate is not necessary when using BNC, Aux, or HDMI In.

**JAM** With the MixPre to Free Run and the frame rate set to the source's frame rate, tap Source and select BNC In or Aux TC. Tap Jam TC to jam timecode. Jamming is successful if Diff = 00:00:00:00.

**SET TC** Manually set timecode.

**BNC IN** MixPre-10 II only. Set BNC to Timecode or Word Clock.

**BNC OUT** MixPre-10 II only. Set BNC to Timecode or Word Clock.

**SYNC REF** MixPre-10 II only. Select from BNC In or Internal. When BNC In is selected, the MixPre-10 II can be set to sync to an external timecode or word clock sync reference connected to BNC In.

**SET UBITS** Click "Mode" at top to edit UBits Mode. From the main screen, press in with the headphone encoder to modify the value of a UBit. Use the arrows or scroll with the encoder to select.

*To maintain accurate timecode count over a power cycle, ensure MixPre is not connected as a USB audio interface to a computer during power up. It is best practice to rejam timecode devices after switching modes (Basic, Advanced or Custom) or after any setting change requiring a reboot (32-bit float, MixAssist, Music mode or Ambisonics).*



## Timecode Modes

**FREE RUN** Timecode runs continuously. Timecode continues counting accurately for up to four hours after power-down.

**REC RUN** Timecode runs while recording and is stationary when not recording. In this mode, timecode defaults to the last stationary value at power-up. When switching to Record Run from another mode, the internal generator will stop at the last timecode value. Timecode output can be used to trigger other equipment that supports timecode remote triggering to start and stop recording.

**TIME OF DAY (TOD)** Alternatively known as 24 hr run mode, this is similar to free run mode except that the timecode generator is automatically loaded with the time of day. Use TOD mode when you want the recorded WAV files to be timecode stamped with the time of day generated by the internal clock.

**BNC IN, AUX IN** Timecode can be derived from external timecode connected to the TC In BNC or to the 3.5 mm Aux/Mic In connector.

**HDMI TC IN** Many DSLR-style cameras output timecode via HDMI. If HDMI TC In is selected without an HDMI source connected, the MixPre II will report missing sync. The MixPre II has two HDMI timecode modes. HDMI flag for Sony, Panasonic, Nikon, Canon and Blackmagic cameras and HDMI FUJIFILM for FUJIFILM cameras.

**OFF** Setting TC Mode to Off disables the timecode feature. When Off, the time counter below the filename region on the home screen displays elapsed time instead of timecode.

## Presets

If you plan to use the MixPre II in a wide variety of situations, you can store and recall snapshots of all of the MixPre II's settings. Setup files can be saved and recalled from the SD card or to one of four internal preset slots. You can also restore the MixPre II to the factory default settings from the Presets menu.

**LOAD** Loads factory defaults or user presets from SD Card or from one of four internal slots.

**SAVE TO INT 1** Saves the current setup to internal slot 1.

**SAVE TO INT 2** Saves the current setup to internal slot 2.

**SAVE TO INT 3** Saves the current setup to internal slot 3.

**SAVE TO INT 4** Saves the current setup to internal slot 4.

**SAVE TO SD** Saves the current setup to the SD card.

## Projects

**NEW** Create a custom project name or project name based on the current date. Names may be up to 18 characters long.

**OPEN** Select the required project. This will load the File List with the selected Project's files.

**COPY** Select the project to copy to a USB-A Drive.

**TRASH PROJECT** Select which project to trash. This moves the selected project and all its files to the TRASH folder. Projects in this folder are accessible using a computer. You can permanently delete projects in the SD card's TRASH folder using a computer or by formatting the card.

**CREATE REPORT** The MixPre II includes the ability to create a .csv sound report file for the active project. It contains useful descriptive information about the project settings and all its recorded files. This can be used as a log of your recording session or as an electronic report that you can send along with your audio files to post-production or a client. The .csv sound report file is stored in the active project's folder alongside audio files and is named as follows: ActiveProject-Name\_Report.csv

**REPORT INFO** The MixPre II can customize the sound report's descriptive header information to include various project details, such as Producer, Director, Job, Name, Location, Phone, E-mail, Client, etc. Enter details for each info item using the on-screen virtual keyboard, a USB keyboard. If items are blank, they will not be included in the report file.

## File List - Basic Mode

### TO ACCESS THE FILE LIST

1. Touch the filename at the top of the Home screen.
2. Scroll through the chronological list of all files in an active project with the headphone encoder. The top item in the list is the next file to be recorded. Directly below that is the last recorded file or file currently being recorded, followed by all previously recorded files.
3. Press Edit or push the headphone encoder in to access sub-menus for each file.



### TO PLAYBACK A FILE FROM THE LIST

Scroll to a file and press Play to play it back.

**NAME** Edit the file's name.

**NUMBER** Edit the file's number.

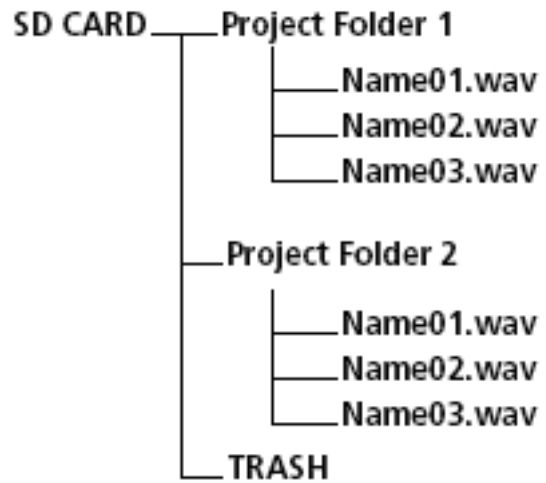



## File List - Advanced Mode

### TO ACCESS THE FILE LIST

1. Touch the filename at the top of the Home screen.
2. Scroll through the chronological list of all files in an active project with the headphone encoder. The top item in the list is the next file to be recorded. Directly below that is the last recorded file or file currently being recorded, followed by all previously recorded files.
3. Press Edit or push the headphone encoder in to access sub-menus for each file.



### TO PLAYBACK A FILE FROM THE LIST

Select a file and press Play to play it back.

**UNDO** Undo moves the last recorded file to the SD card's UNDO folder and resets the number of the next file. Files in this folder are accessible using a computer.

**NAME, NUM, NOTES** Edit the file's name, number, and, in advanced mode, make notes.

**TRACK NAMES** Edit track names within a file.

**RENAME** Rename the file's name and number.

**TRASH FILE** Deletes the file.

**CUE LIST** Brings up list of all cue marks added during record or playback. Name, move, and delete cue marks on this list.

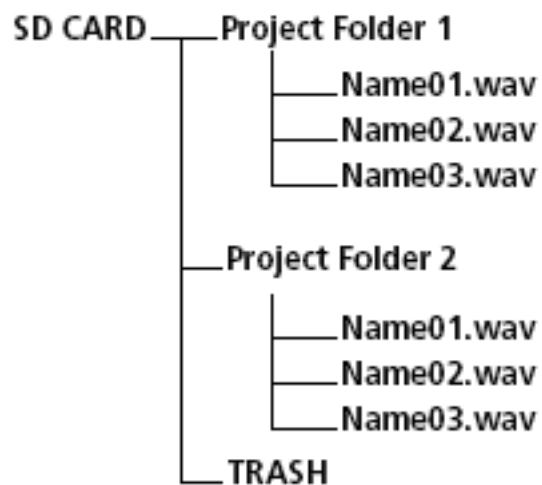

# Cue Marks

Use cue marks to make it easy to locate quickly to points of interest. The MixPre automatically rennumbers cue marks if one is inserted between existing cue marks to maintain their ascending numerical order from start to finish—01, 02, 03, etc. You may have a maximum of 99 per file. Cues appear in numerical order in the Cue List, such as those shown in following image.

## ADD A CUE MARK

1. During recording, playback, or pause, tap  , the Q icon at the top of the Home screen to add a cue mark.
2. A cue mark number (starting from 01 and incrementing each time a new cue mark is added) is displayed next to the Q icon.

## ACCESS THE CUE LIST

1. Tap  .
2. Use the HP encoder to select a file (or highlight a file and tap Edit).
3. Tap Cue List from menu.
4. Cues may be named, moved, deleted from the Cue List.

## NAME A CUE MARK

1. From the Cue List, use the HP encoder to select a cue mark.
2. Tap Name and enter a new name.

## MOVING CUE MARKS

You can finely tune the position of cue marks in 0.1 second increments.

1. From the Cue List, use the HP encoder to select a cue mark.
2. Tap Move and rotate the HP encoder to adjust the selection in 0.1 second increments.

## DELETING A SINGLE CUE MARK

1. From the Cue List, select a cue mark.

## CLEAR A POINT

1. Select an individual Play In, Record In/Out, or Stop point from the Cue List and tap Disable.

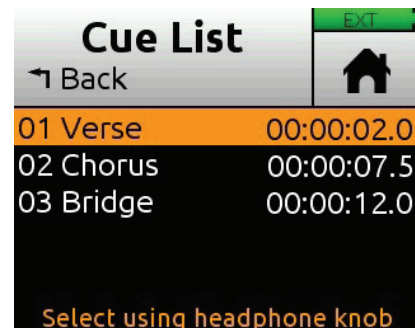
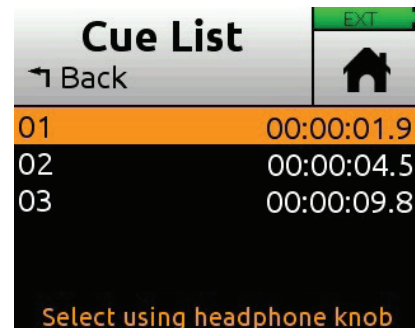

## Using Star Shortcuts (\*/\*\*)

### **MIXPRE-6 II**

For your convenience, we have included a front panel programmable button. This lets you dedicate a hardware shortcut to frequently used functions without having to navigate the menus. Program the \* button in the \*Button menu.

### **MIXPRE-10 II**

For your convenience, we have included a two-position programmable toggle switch on the front panel. This lets you dedicate hardware shortcuts to frequently used functions. Program the \* and \*\* switch in the \*Shortcuts menu.

### **PROGRAMMABLE FUNCTIONS**

1. Ch 5/6 Screen Toggle (MixPre-6 II)
2. Ch 9/10 Screen (MixPre-10 II)
3. Solo/Mute screen
4. Project screen
5. SD Card screen
6. Undo
7. Slate Mic
8. Tone
9. Q
10. St Out Mute (MixPre-6 II)
11. L/R Mute (MixPre-10 II)
12. X1/X2 Mute (MixPre-10 II)

# Wingman Application

Sound Devices Wingman is a free app that allows wireless remote control of the Bluetooth Smart-enabled MixPre Series from iOS or Android devices.

## VIEWING AREA

On smaller devices, the viewing area displays transport and track views. Swipe horizontally to toggle between views. On larger devices, the viewing area shows only transport view.

## TRANSPORT VIEW

Displays control buttons, metadata fields, and meters. Swiping vertically toggles to other meters. On larger devices, arming and naming of tracks is done in transport view.

## TRACK VIEW

On smaller devices, arming and naming of tracks is done in track view.

## RENAMING TRACKS

1. On large mobile devices, from the Transport view, tap anywhere in a vertical meter for the track you want to edit.
2. On small mobile devices, swipe horizontally to display the Track view, then tap anywhere in a horizontal meter for the track you want to edit.
3. Use the virtual on-screen keyboard to modify the track name.
4. Tap Done when finished to save the changes.
5. Tap anywhere on screen other than the keyboard to exit without saving changes.

## ARMING/DISARMING TRACKS

1. Tap the meter label. When armed the label turns red. When on but disarmed, the label is gray. When the input is off, the label is black and cannot be armed.
2. Meter labels are joined (displayed as a single label) to indicate when channels are linked.

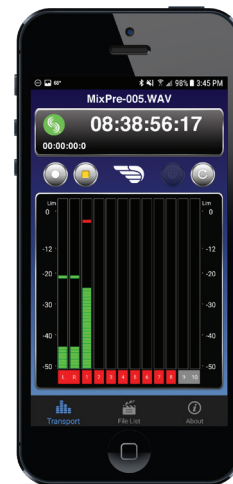
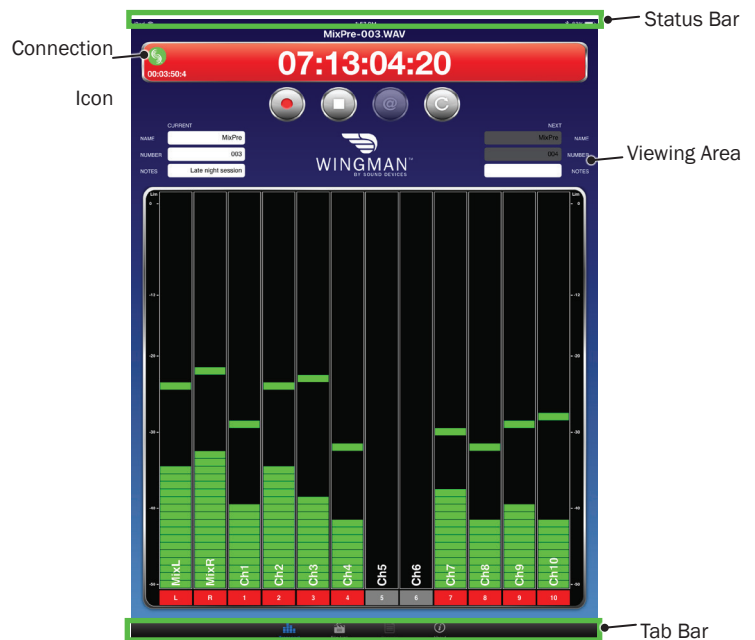

Transport View

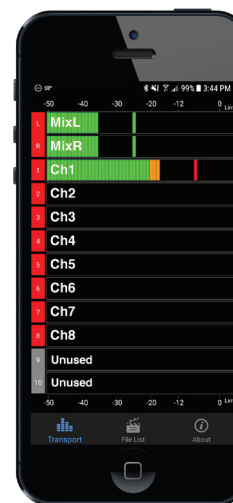





Track View

**CONNECTION ICON**

Tap the Connection icon to efficiently switch connection from one device to another from within the app. Tapping the Circled-I icon helps identify a listed MixPre by displaying an “Identifying from Wingman” message on the chosen recorder’s screen.

**CONNECTION ICON STATUS COLORS**

Gray		Disconnected - either no activity or scanning for devices
Orange		Bluetooth connection in progress
Yellow		Connected - authentication underway
Green		Connected and authenticated

**ENABLE BLUETOOTH ON THE MIXPRE** This toggles Bluetooth On and Off. If a remote password is configured on the recorder in the System>Wingman Password menu, Wingman will prompt for that password to be entered prior to making the connection.

**SET AND CLEAR THE WINGMAN PASSWORD**

For added security, set up the MixPre recorder to require a password for remote access. Use the virtual keyboard or a USB keyboard to enter a password up to 18 alpha-numeric characters . Punctuation other than a hyphen or an underscore is not permitted.

**FILE LIST TAB**

MixPre files and their embedded BWF/iXML metadata can be viewed and edited in the File List tab.

**SOUND REPORT**

Sound reports can be created and sent direct from Wingman as .csv files.

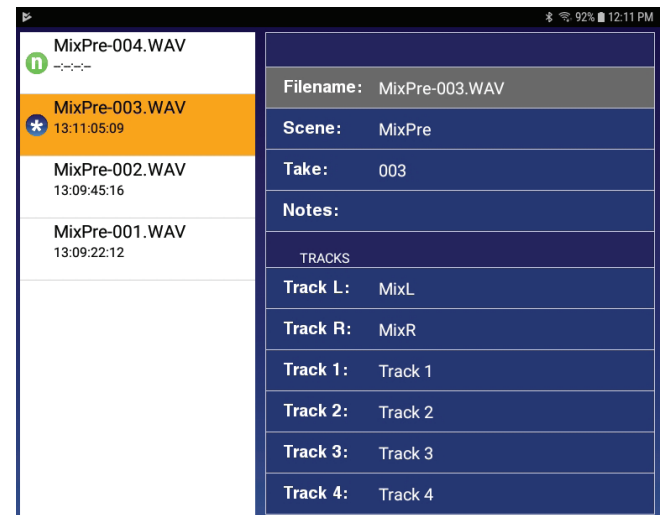
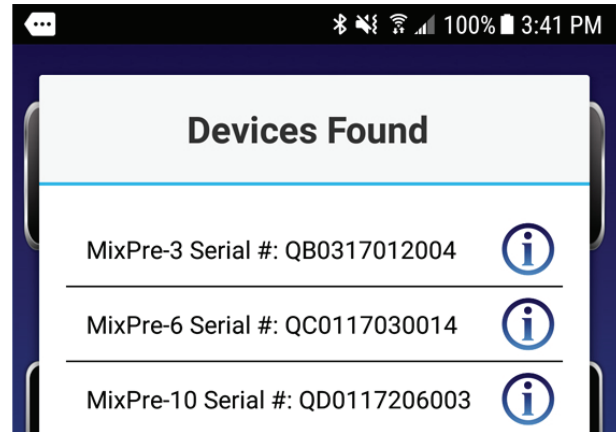

## USB Hub

The MixPre will support multiple USB devices such as USB thumb drives, Midi controllers, and/or USB Keyboards via a USB hub.

To maximize USB hub support, note:

Powered hubs are recommended as these can deliver appropriate current.

If using non-powered hubs, do not connect more than three low power devices.

Connect each USB device individually rather than all at once. The peak current of all three devices at once may exceed the max peak current of the supply.

If devices are randomly unmounting there is not enough current to power all the attached devices. Remove one or more devices or use a powered hub.

USB-A support (with or without hub) is only available when MixPre is fully powered and not in low power mode.

Only one USB controller can be used at a time.

Only one USB drive can be used at a time.

When using non-powered hubs with the MixPre 3 II or 6 II, use an L-mount battery, a 4-pin Hirose DC adapter (e.g. from Hawkwoods), a USB-C wall adapter, or USB-C battery pack (e.g. from Anker or Ravpower). USB-C from a computer may not provide sufficient power to operate all USB devices connected to a non-powered USB hub.

The USB-A port does not support hubs when being powered from AA batteries.

Use a high quality USB-C to C cable when powering from a USB-C power source, preferably one meter or less. Low quality USB-C cables could cause erratic behavior.

# USB Keyboard

A connected USB keyboard may be used as a wired remote control for certain functions. Holding a keyboard function for longer than 0.5 seconds will repeat the shortcut action.

KEYSTROKE	DESCRIPTION
Escape	Back. Also cancels out of editing mode when virtual keyboard is on screen
F1 or Menu key	Accesses the Main menu
F12	Home
F2	File list
F3	Cycles between available Meters views and the Main screen
Ctrl + R	Record
Ctrl + S	Stop
Spacebar	Play
Left Arrow	Main screen: Rewind Menu and Channel screens: Toggles through pages
Right Arrow	Main screen: Fast forward Menu and Channel screens: Toggles through pages
Up / Down Arrows	Main screen: Adjusts headphone volume In menus: Duplicates encoder rotation, such as moves highlight, scrolls list While editing parameters: Changes the value
Enter	In menus: Activates current selection. (Same as encoder press.) Also, same as choosing OK when virtual keyboard is on screen
Q	In menus: select top left option in quad button view
W	In menus: select top right option in quad button view MixPre-10 II: Top Center
A	In menus: select bottom left option in quad button view
S	In menus: select bottom right option in quad button view MixPre-10 II: Bottom Center
E	MixPre-10 II menus: Top Right
D	MixPre-10 II menus: Bottom Right
1-0	Channel screen for 1-10
*	Toggles assigned * Shortcut Action
Ctrl + M	Add cue mark
Ctrl + F	File transfer mode
Ctrl + 1-0	Toggle Arm status of Channels 1-10
Option + 1-0	Solo Channels 1-10
Ctrl + Option + 1-0	Mute Channels 1-10
1 + 2 + 3	Front Panel Lock Menu

**X-KEYS® PROGRAMMABLE KEYPADS, STICKS & KEYBOARDS**

X-keys include a variety of compact, tactile input devices that can be programmed to emulate USB keyboard commands. Their various buttons and tactile controls are programmed via P.I. Engineering's MacroWorks Windows software. When mapped as individual commands or as macro commands to MixPre's USB Keyboard shortcuts listed above, they offer quick-access to many MixPre functions including Record, Stop, Play, and many more.

To use with MixPre, the X-Keys device must be connected to the MixPre's USB-A port.

Please visit P.I. Engineering's website for more information.



## USB Controllers

The MixPre II Series can be connected to select third party controllers for tactile control of mixing and recording. These control surfaces provide a varied range of physical sliders, pots, and buttons to set fader levels, trim gains, pans, reverb sends, solos, mutes, record arming, transport control and more. Functionality varies depending on controller model. When connected to the MixPre II, some functions are taken over by the controller and are therefore disabled on the MixPre II.

### COMPATIBLE RECORDERS

1. Korg NanoKontrol Studio
2. Korg NanoKontrol 2
3. Novation LaunchControl XL
4. AKAI MidiMix

### CONNECTING THE MIXPRE TO A CONTROLLER

Power and control is provided via a single USB cable to better facilitate simple connection between the MixPre and controller. For the MixPre-3 II and -6 II, USB Controllers will only function if the MixPre is adequately powered.

1. The MixPre may be powered on before USB connection or may be turned on after USB connection.
2. Connect one end of a USB cable to the MixPre's USB-A port and the other end to the controller's USB port, which can be a USB-B, Micro USB, or Mini USB port, depending on the controller model. We recommend using the USB cable supplied with the controller.
3. A popup screen displays the controller model. After a few seconds of configuration, the popup closes and the controller is ready to use.

### MAP USER-DEFINABLE BUTTONS TO FUNCTIONS

1. Connect a controller.
2. On the MixPre, access Menu > \* Shortcuts > Control Surface
3. Set any of the user-definable shortcut buttons to the assignable functions listed below.

### ASSIGNABLE FUNCTIONS

1. Tone
2. L/R Mute
3. X1/X2 Mute
4. Undo
5. Slate Mic
6. Add Q
7. Record
8. Stop
9. Play
10. Rewind
11. Fast Fwd
12. Shuttle (not all controllers)



AKAI MidiMix



Korg NanoKontrol 2



Korg NanoKontrol Studio



Novation LaunchControl XL

## Akai MidiMix Interface Functions

FUNCTION	ACTION
Fader Bank Switching	--
User-Definable Shortcut Buttons	Solo + Bank Left Solo + Bank Right
Record	via user-definable shortcut
PLAY	via user-definable shortcut
STOP	via user-definable shortcut
FFWD X2, X16	via user-definable shortcut
RWD X2, X16	via user-definable shortcut
Skip Next File	via user-definable shortcut (Tap Fast Forward)
Skip Prev File	via user-definable shortcut (Tap Rewind)
Skip Next Mark	via user-definable shortcut (Fast Forward)
Skip Prev Mark	via user-definable shortcut (Rewind)
Return to Zero	via user-definable shortcut (Stop)
Shuttle	Only via MixPre
Record Arm	REC Arm button
Record Arm Status	Red REC Arm button when armed
Input Monitor	--
Input Monitor Status	--
Channel Screen Access	Solo + REC Arm buttons
Faders	Linear faders 1-8
Trims	Top row knobs
Pans	Bottom row knobs
Reverb	--
Low Cut	Middle row knobs
Mute	Mute button
Solo	Solo + Mute buttons
Mute Status	Yellow Mute button
Solo Status	Yellow Mute button when Solo is pressed
L/R (Stereo) Output Gain	Master fader
L/R (Stereo) Output Mute	via user-definable shortcut
X1/X2 Mute (10 II only)	via user-definable shortcut
Tone	via user-definable shortcut
Metronome	--
Create Q	via user-definable shortcut
Undo	via user-definable shortcut
Internal Mic (10 II only)	via user-definable shortcut
SEND ALL Button	Sends all current fader, knob settings to MixPre

## Korg NanoKontrol 2 Interface Functions

FUNCTION	ACTION
Fader Bank Switching	--
User-Definable Shortcut Buttons	Cycle + Marker Set Cycle + Marker < Cycle + Marker > Cycle + << Cycle + >>
Record	Record button
PLAY/Pause	Play button
STOP	Stop button
FFWD X2, X16	Hold >> button
RWD X2, X16	Hold << button
Skip Next File	Tap >> button
Skip Prev File	Tap << button
Skip Next Mark	Tap >> button
Skip Prev Mark	Tap << button
Return to Zero	Tap Stop
Shuttle	Only via MixPre
Record Arm	R button
Record Arm Status	Red R button when armed
Input Monitor	--
Input Monitor Status	--
Channel Screen Access	Cycle + S button
Faders	Linear faders 1-8
Trims	Rotary knobs (set to trim)
Pans	Rotary knobs (set to pan)
Reverb	--
Low Cut	Rotary knobs (set to low-cut)
Mute	M button
Solo	S button
Mute Status	Red M button
Solo Status	Red S button
L/R (Stereo) Output Gain	Only via MixPre
L/R (Stereo) Output Mute	via user-definable shortcut
X1/X2 Mute (10 II only)	via user-definable shortcut
Tone	via user-definable shortcut
Metronome	--
Create Q	Marker Set button
Undo	via user-definable shortcut
Internal Mic (10 II only)	via user-definable shortcut

## Korg NanoKontrol Studio Interface Functions

FUNCTION	ACTION
Fader Bank Switching	--
User-Definable Shortcut Buttons	Cycle + Marker Set Cycle + Marker < Cycle + Marker > Cycle + << Cycle + >>
Record	Record button
PLAY	Play button
STOP	Stop button
FFWD X2, X16	Hold >> button
RWD X2, X16	Hold << button
Skip Next File	Tap >> or Marker > button
Skip Prev File	Tap << or Marker < button
Skip Next Mark	Tap >> or Marker > button
Skip Prev Mark	Tap << or Marker < button
Return to Zero	Tap  < or Stop
Shuttle	Press MixPre HP encoder or set Shuttle as a shortcut, then use selected shortcut and scrub wheel.
Record Arm	REC Arm button
Record Arm Status	White REC Arm button when armed
Input Monitor	--
Input Monitor Status	--
Channel Screen Access	Select button
Faders	Linear faders 1-8
Trims	Scene 1 then use knobs
Pans	Scene 3 then use knobs
Reverb	--
Low Cut	Scene 2 then use knobs
Mute	Mute button
Solo	Solo button
Mute Status	White Mute button
Solo Status	White Solo button
L/R (Stereo) Output Gain	Only via MixPre
L/R (Stereo) Output Mute	via user-definable shortcut
X1/X2 Mute (10 II only)	via user-definable shortcut
Tone	via user-definable shortcut
Metronome	--
Create Q	Marker Set button
Undo	via user-definable shortcut
Internal Mic (10 II only)	via user-definable shortcut

## Novation LaunchControl XL Interface Functions

FUNCTION	ACTION
Fader Bank Switching	--
User-Definable Shortcut Buttons	UP DOWN Device + UP Device + Down Device + Left Device + Right
Record	via user-definable shortcut
PLAY	via user-definable shortcut
STOP	via user-definable shortcut
FFWD X2, X16	via user-definable shortcut
RWD X2, X16	via user-definable shortcut
Skip Next File	via user-definable shortcut
Skip Prev File	via user-definable shortcut
Skip Next Mark	via user-definable shortcut
Skip Prev Mark	via user-definable shortcut
Return to Zero	via user-definable shortcut (Stop)
Shuttle	Only via MixPre
Record Arm	Select Record Arm, then Track Control button
Record Arm Status	Red Track Control button when Record Arm is selected
Input Monitor	--
Input Monitor Status	--
Channel Screen Access	Track Focus buttons
Faders	Linear Faders 1-8
Trims	Top row of knobs
Pans	Bottom row of knobs
Reverb	--
Low Cut	Middle row of knobs
Mute	Select Mute, then Track Control button
Solo	Select Solo, then Track Control button
Mute Status	Red Track Control button when Mute is selected
Solo Status	Flashing Track Control button when Solo is selected
L/R (Stereo) Output Gain	Only via MixPre
L/R (Stereo) Output Mute	via user-definable shortcut
X1/X2 Mute (10 II only)	via user-definable shortcut
Tone	via user-definable shortcut
Metronome	--
Create Q	via user-definable shortcut
Undo	via user-definable shortcut
Internal Mic (10 II only)	via user-definable shortcut

## Mounting to a Camera or Tripod

All MixPre II Series recorders have ¼-inch, 20-threaded screw mounts on their top and bottom panels for mounting to gear.

To attach your MixPre II between a camera and tripod:

1. Remove the battery sled to gain access to the back panel.
2. Retrieve the anti-rotation pin and Allen wrench. Both are magnetically held in place in the back panel.
3. From the MixPre II's bottom panel, insert the Allen wrench into the mounting screw hole and push up to reveal the retractable screw. Rotate to screw the MixPre II into place underneath the camera.
4. Align the mounting screw hole on the bottom panel of the MixPre II with the screw on the tripod plate. Rotate the screw on the tripod plate until the MixPre II is affixed.

If your camera has a slot for the anti-rotation pin, screw the pin into place on top of the MixPre II, and then position the MixPre II against the bottom of the camera so that the pin fits into the camera's slot. The anti-rotation pin may also be screwed into a tripod and slotted into the bottom of the MixPre II.

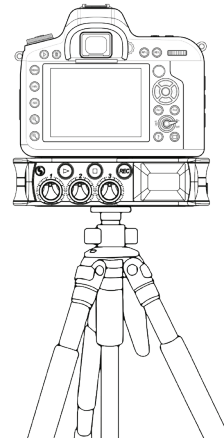
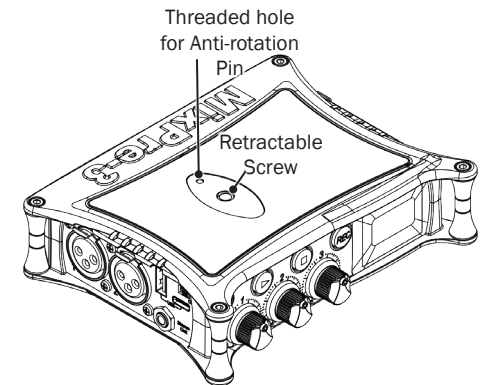
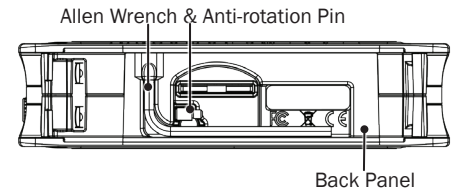

# MixPre-3 II Specifications

Specifications are subject to change without prior notice.  
For the latest information available on all Sound Devices products, visit our website: [www.sounddevices.com](http://www.sounddevices.com).

## FREQUENCY RESPONSE

10 Hz to 80 kHz +/- 0.5 dB re 1 kHz @ 192 kHz sample rate

## THD + NOISE

0.005% max (@1 kHz, 22-22 kHz BW, gain= 20 dB, -10 dBu in)

## ADC\*

32 bit precision; 142 dB dynamic range min (A weighted, gain = 10 dB, fader = 0 dB)

## EQUIVALENT INPUT NOISE

-130 dBV (-128 dBu) max (A-weighting, gain = 76 dB, 150 ohm source impedance)

## INPUTS

Mic: XLR active-balanced; 4k input  
Line: XLR active-balanced; 4k input  
Aux/Mic in: 3.5 mm TRS, 2-channel unbalanced; 100k input  
USB Audio: 2 channels  
5 Total analog inputs: 3 mic-line inputs, 2 on Aux In  
All inputs fully RF-filtered and overload protected

## GAIN

Mic input: +6 dB to +76 dB  
Line input: -20 dB to +30 dB  
Fader: -inf to +20 dB  
Headphone: -inf to +20 dB  
Total, Mic-to-recording (max): +96 dB  
Aux In (Mic): Gain = +10 dB to +40 dB  
Aux In (Line): Gain = -10 dB to +20 dB  
Total Aux Gain including Fader (Mic-to-recording): +60 dB

## MAXIMUM INPUT LEVEL

Mic XLR: +14 dBu (limiters on or off)  
Line XLR/¼-inch: +28 dBu (limiters on or off)  
Aux In (Mic): -10 dBu  
Aux In (Line): +10 dBu

## LOW-CUT FILTERS

40 Hz to 160 Hz (adjustable), 18 dB/oct. First stage analog, subsequent stages digital

## LIMITERS (16- and 24-bit operation only)

Limiter at all gain stages, range > 40 dB  
First stage analog, subsequent stages digital  
Adjustable threshold, ratio, and release

## MICROPHONE POWERING

Mic XLRs: 48 V via 6.8k resistors, 10 mA each  
Mic 3.5 mm: 3 V @ 3k source

## OUTPUTS

3.5 mm TRS stereo unbalanced, 500 ohm output impedance, +7.8 dBu max output level

## HEADPHONE OUTPUTS

3.5 mm TRS stereo unbalanced, 300 mW + 300 mW, for use with any impedance headphones

## DAC FEEDING STEREO OUT, HEADPHONE OUT

32 bit precision; 115 dB dynamic range (A-weighted)

## USB

Audio Interface (USB-C): 6-in/2-out (from computer); 44.1 kHz/48 kHz/96 kHz; 16/24/32-bit integer, 32-bit float; Class-compliant USB 2.0 high speed driver  
Mass Storage (USB-C): USB 2.0 high speed  
Keyboard, X-Keys (USB-A): Text entry and control  
Thumbdrive (USB-A): Manual or auto-copy to drive  
Midi Control Surface (USB-A)  
USB Hub

## RECORDING

5 Tracks: stereo mix + 3 ISO's  
44.1 kHz, 47.952 kHz, 48 kHz, 48.048 kHz, 96 kHz, 192 kHz sampling frequencies  
16, 24, 32 float bit depths  
Polyphonic WAV

## RECORDING STORAGE

Type: SD, SDXC, SDHC Card, & USB thumbdrive (copy only)  
Max Storage Size: 512 GB (SDXC)  
Card format: exFAT

## TIMECODE

Modes: Free Run, Time of Day (file stamped w/current ToD), Rec Run, Ext LTC (file stamped w/incoming LTC on 3.5mm Aux In), Camera TC (file stamped w/incoming TC from cameras that output TC)  
Frame Rates: auto-detects (fps): 23.98 (same as 23.976), 24, 25, 29.97DF, 29.97ND, 30, 30DF  
3.5 mm Aux In Timecode Input: 20k ohm impedance, 0.3 V - 3.0 V p-p (-17 dBu - +3 dBu)  
3.5 mm Stereo Out Timecode Output: 1k ohm impedance, 3.0V p-p (+12 dBu)  
TC Reader via HDMI

## POWER

AA Batteries: 4x AA sled (included); 8x AA sled (optional accessory). Energizer Ultimate Lithium recommended  
L-Mount: Optional sled for 2x (hot-swappable) Li-ion batteries  
From computer: Bus-powered via USB-C port optional MX-USBY cable, connects one USB-C to two USB-A ports  
AC Adapter: MX-PSU (included) Power supply wall adapter w/ USB-C connector; 15 W; has 4 adapter plugs for US, UK, AU & Europe

## REMOTE CONTROL

Bluetooth LE: Wireless control using Wingman app  
HDMI (micro): Auto-record start/stop trigger from cameras with output record flag over HDMI  
Timecode: Auto-record start/stop trigger via Aux In timecode

## ENVIRONMENTAL

Operating: -20 °C to 60 °C, 0 to 90% relative humidity; (non-condensing)  
Storage: -40 °C to 85 °C

## DIMENSIONS AND WEIGHT

36 mm x 144 mm x 110 mm (H x W x D); 1.40" x 5.68" x 4.35"  
Weight: .48 kg; 16.8 oz. (unpacked, without batteries)  
Touch Screen: 320x256; 1.6-inch, color, sunlight-viewable IPS LCD

\*patents #US9654134B2 (USA), #CA2973142C (Canada), and #EP3259845 (Europe)

# MixPre-6 II Specifications

Specifications are subject to change without prior notice. For the latest information available on all Sound Devices products, visit our website: [www.sounddevices.com](http://www.sounddevices.com).

## FREQUENCY RESPONSE

10 Hz to 80 kHz +/- 0.5 dB re 1 kHz @ 192 kHz sample rate

## THD + NOISE

0.005% max (@1 kHz, 22-22 kHz BW, gain= 20 dB, -10 dBu in)

## ADC\*

32 bit precision; 142 dB dynamic range min (A weighted, gain = 10 dB, fader = 0 dB)

## EQUIVALENT INPUT NOISE

-130 dBV (-128 dBu) max (A-weighting, gain = 76 dB, 150 ohm source impedance)

## INPUTS

Mic: XLR active-balanced; 4k input  
 Line: XLR active-balanced; 4k input  
 Aux/Mic in: 3.5mm TRS, 2-channel unbalanced; 100k input  
 Line: ¼-inch TRS active-balanced; 4k input  
 USB Audio: 4 channels  
 6 Total analog inputs: 4 mic-line inputs, 2 on Aux In  
 All inputs fully RF-filtered and overload protected

## GAIN

Mic input: +6 dB to +76 dB  
 Line input: -20 dB to +30 dB  
 Fader: -inf to +20 dB  
 Headphone: -inf to +20 dB  
 Total, Mic-to-recording (max): +96 dB  
 Aux In (Mic): Gain = +10 dB to +40 dB  
 Aux In (Line): Gain = -10 dB to +20 dB  
 Total Aux Gain including Fader (Mic-to-recording): +60 dB

## MAXIMUM INPUT LEVEL

Mic XLR: +14 dBu (limiters on or off)  
 Line XLR/¼-inch: +28 dBu (limiters on or off)  
 Aux In (Mic): -10 dBu  
 Aux In (Line): +10 dBu

## LOW-CUT FILTERS

40 Hz to 160 Hz (adjustable), 18 dB/oct. First stage analog, subsequent stages digital

## LIMITERS (16- and 24-bit operation only)

Limiter at all gain stages, range > 40 dB  
 First stage analog, subsequent stages digital  
 Adjustable threshold, ratio, and release

## MICROPHONE POWERING

Mic XLRs: 48 V via 6.8k resistors, 10 mA each  
 Mic 3.5 mm: 3 V @ 3k source

## OUTPUTS

3.5 mm TRS stereo unbalanced, 500 ohm output impedance, +7.8 dBu max output level

## HEADPHONE OUTPUTS

3.5 mm TRS stereo unbalanced, 300 mW + 300 mW, for use with any impedance headphones

## DAC FEEDING STEREO OUT, HEADPHONE OUT

32 bit precision; 115 dB dynamic range (A-weighted)

## USB

Audio Interface (USB-C): 8-in/4-out; 44.1 to 96 kHz; 16/24/32-bit integer, 32-bit float; Class-compliant USB 2.0 high speed or ASIO® (supplied via download)  
 Mass Storage (USB-C): USB 2.0 high speed  
 Keyboard, X-Keys (USB-A): Text entry and control  
 Thumbdrive (USB-A): Manual or auto-copy to drive  
 Midi Control Surface (USB-A)  
 USB Hub

## RECORDING

8 Tracks: stereo mix + 6 ISOs  
 44.1 kHz, 47.952 kHz, 48 kHz, 48.048 kHz, 96 kHz, 192 kHz sampling frequencies  
 16, 24, 32 float bit depths  
 Polyphonic WAV

## RECORDING STORAGE

Type: SD, SDXC, SDHC Card, & USB thumbdrive (copy only)  
 Max Storage Size: 512 GB (SDXC)  
 Card format: exFAT

## TIMECODE

Modes: Free Run, Time of Day (file stamped w/current ToD), Rec Run, Ext LTC (file stamped w/incoming LTC on 3.5mm Aux In), Camera TC (file stamped w/incoming TC from cameras that output TC)  
 Frame Rates: auto-detects (fps): 23.98 (same as 23.976), 24, 25, 29.97DF, 29.97ND, 30, 30DF  
 3.5 mm Aux In Timecode Input: 20k ohm impedance, 0.3 V - 3.0 V p-p (-17 dBu - +3 dBu)  
 3.5 mm Stereo Out Timecode Output: 1k ohm impedance, 3.0V p-p (+12 dBu)  
 TC Reader via HDMI

## POWER

AA Batteries: 4x AA sled (included); 8x AA sled (optional accessory). Energizer Ultimate Lithium recommended  
 L-Mount: Optional sled for 2x (hot-swappable) Li-ion batteries  
 From computer: Bus-powered via USB-C port: optional MX-USBY cable, connects one USB-C to two USB-A ports  
 AC Adapter: MX-PSU (included) Power supply wall adapter w/ USB-C connector; 15 W; has 4 adapter plugs for US, UK, AU & Europe

## REMOTE CONTROL

Bluetooth LE: Wireless control using Wingman app  
 HDMI (micro): Auto-record start/stop trigger from cameras with output record flag over HDMI  
 Timecode: Auto-record start/stop trigger via Aux In timecode

## ENVIRONMENTAL

Operating: -20°C to 60°C, 0 to 90% relative humidity; (non-condensing)  
 Storage: -40°C to 85°C

## DIMENSIONS AND WEIGHT

36mm x 166 mm x 118 mm (H x W x D); 1.40" x 6.53" x 4.65"  
 Weight: .56 kg; 19.9 oz. (unpacked, without batteries)  
 Touch Screen: 320x256; 1.6-inch, color, sunlight-viewable IPS LCD

\*patents #US9654134B2 (USA), #CA2973142C (Canada), and #EP3259845 (Europe)



# MixPre-10 II Specifications

Specifications are subject to change without prior notice.  
For the latest information available on all Sound Devices products, visit our website: [www.sounddevices.com](http://www.sounddevices.com).

## FREQUENCY RESPONSE

10 Hz to 80 kHz +/- 0.5 dB re 1 kHz @ 192 kHz sample rate

## THD + NOISE

0.005% max (@1 kHz, 22-22 kHz BW, gain= 20 dB, -10 dBu in)

## ADC\*

32 bit precision; 142 dB dynamic range min (A weighted, gain = 10 dB, fader = 0 dB)

## EQUIVALENT INPUT NOISE

-130 dBV (-128 dBu) max (A-weighting, gain = 76 dB, 150 ohm source impedance)

## INPUTS

Mic: XLR active-balanced; 4k input  
Line: XLR active-balanced; 4k input  
Aux/Mic in: 3.5mm TRS, 2-channel unbalanced; 100k input  
Line: ¼-inch TRS active-balanced; 4k input  
USB Audio: 4 channels  
10 Total analog inputs: 8 mic-line inputs, 2 on Aux In  
All inputs fully RF-filtered and overload protected

## GAIN

Mic input: +6 dB to +76 dB  
Line input: -20 dB to +30 dB  
Fader: -inf to +20 dB  
Headphone: -inf to +20 dB  
Total, Mic-to-recording (max): +96 dB  
Aux In (Mic): Gain = +10 dB to +40 dB  
Aux In (Line): Gain = -10 dB to +20 dB  
Total Aux Gain including Fader (Mic-to-recording): +60 dB

## MAXIMUM INPUT LEVEL

Mic XLR: +14 dBu (limiters on or off)  
Line XLR/¼-inch: +28 dBu (limiters on or off)  
Aux In (Mic): -10 dBu  
Aux In (Line): +10 dBu

## LOW-CUT FILTERS

40 Hz to 160 Hz (adjustable), 18 dB/oct. First stage analog, subsequent stages digital

## LIMITERS (16- and 24-bit operation only)

Limiter at all gain stages, range > 40 dB  
First stage analog, subsequent stages digital  
Adjustable threshold, ratio, and release

## MICROPHONE POWERING

Mic XLRs: 48 V via 6.8k resistors, 10 mA each  
Mic 3.5 mm: 3 V @ 3k source

## OUTPUTS

L/R: TA3 2-channel balanced, 1.1K max output impedance, +18 dBu max output level  
X1/X2: 3.5 mm TRS stereo unbalanced, 500 ohm output impedance, +7.8 dBu max output level

## HEADPHONE OUTPUTS

3.5 mm TRS stereo unbalanced, 300 mW + 300 mW, for use with any impedance headphones

## DAC FEEDING STEREO OUT, HEADPHONE OUT

32 bit precision; 115 dB dynamic range (A-weighted)

## USB

Audio Interface (USB-C): 12-in/4-out; 44.1 to 96 kHz; 16/24/32-bit integer, 32-bit float; Class-compliant USB 2.0 high speed or ASIO® driver (supplied via download)  
Mass Storage (USB-C): USB 2.0 high speed  
Keyboard, X-Keys (USB-A): Text entry and control  
Thumbdrive (USB-A): Manual or auto-copy to drive  
Midi Control Surface (USB-A)  
USB Hub

## RECORDING

12 Tracks: Stereo mix + 10 ISOs  
44.1 kHz, 47.952 kHz, 48 kHz, 48.048 kHz, 96 kHz, 192 kHz sampling frequencies  
16, 24, 32 float bit depths  
Polyphonic WAV

## RECORDING STORAGE

Type: SD, SDXC, SDHC Card, & USB thumbdrive (copy only)  
Max Storage Size: 512 GB (SDXC)  
Card format: exFAT

## TIMECODE

Modes: Free Run, Time of Day (file stamped w/current ToD), Rec Run, Ext LTC (file stamped w/incoming LTC on 3.5mm Aux In), Camera TC (file stamped w/incoming TC from cameras that output TC)  
Frame Rates: auto-detects (fps): 23.98 (same as 23.976), 24, 25, 29.97DF, 29.97ND, 30, 30DF  
Sync Source: Internal, Word Clock, Ext LTC  
BNC In (TC In): switchable between Timecode (default) or Word Clock Input; 20k ohm impedance, 0.3 V - 3.0 V p-p (-17 dBu - +3 dBu);  
Word Clock: 10k ohm impedance, 1.5V p-p  
BNC Out (TC Out): switchable between Timecode (default) or Word Clock Output; 1k ohm impedance, 3.0V p-p (+12 dBu); Word Clock: 75 ohm impedance, 5V p-p  
TC Reader via HDMI

## POWER

AA Batteries: 8x AA sled (included); Energizer Ultimate Lithium recommended  
L-Mount: Optional sled for 2x (hot-swappable) Li-ion batteries  
AC Adapter: XL-WPH3 (included): Universal, 45 W in-line AC-to-DC power supply Hirose 4-pin DC plug, with detachable IEC power cord; 100-240, 50/60Hz

## REMOTE CONTROL

Bluetooth LE: Wireless control using Wingman app  
HDMI (micro): Auto-record start/stop trigger from cameras with output record flag over HDMI  
Timecode: Auto-record start/stop trigger via Aux In timecode

## ENVIRONMENTAL

Operating: -20 °C to 60 °C, 0 to 90% relative humidity; (non-condensing)  
Storage: -40 °C to 85 °C

## DIMENSIONS AND WEIGHT

36 mm x 206 mm x 175 mm (H x W x D); 1.375" x 8.125" x 6.875"  
Weight: 0.91 kg; 32.1 oz. (unpackaged, without batteries)  
Touch Screen: 320x256; 1.6-inch, color, sunlight-viewable IPS LCD

\*patents #US9654134B2 (USA), #CA2973142C (Canada), and #EP3259845 (Europe)

**SOUND**  **DEVICES**

Post Office Box 576  
E7556 State Rd. 23 and 33  
Reedsburg, Wisconsin 53959 USA

**[support@sounddevices.com](mailto:support@sounddevices.com)**

+1 608.524.0625 main  
+1 608.524.0655 fax  
800.505.0625 toll free

**[www.sounddevices.com](http://www.sounddevices.com)**